

brother®

USER'S GUIDE

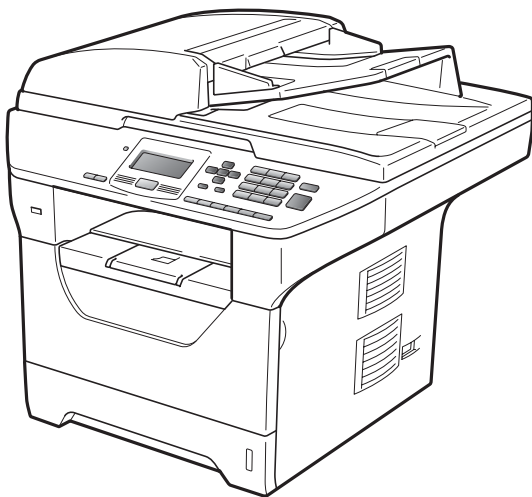

DCP-8085DN

Version A

UK/IRE

If you need to call Customer Service

Please complete the following information for future reference:

Model Number: DCP-8085DN
(Circle your model number)

Serial Number: ¹ _____

Date of Purchase: _____

Place of Purchase: _____

¹ The serial number is on the back of the unit. Retain this User's Guide with your sales receipt as a permanent record of your purchase, in the event of theft, fire or warranty service.

Register your product on-line at

<http://www.brother.com/registration/>

By registering your product with Brother, you will be recorded as the original owner of the product. Your registration with Brother:

- may serve as confirmation of the purchase date of your product should you lose your receipt; and
- may support an insurance claim by you in the event of product loss covered by insurance.

Compilation and Publication Notice

Under the supervision of Brother Industries Ltd., this manual has been compiled and published, covering the latest product descriptions and specifications.

The contents of this manual and the specifications of this product are subject to change without notice.

Brother reserves the right to make changes without notice in the specifications and materials contained herein and shall not be responsible for any damages (including consequential) caused by reliance on the materials presented, including but not limited to typographical and other errors relating to the publication.

Table of Contents

Section I General

1	General information	2
	Using the documentation	2
	Symbols and conventions used in the documentation	2
	Accessing the Software User's Guide and Network User's Guide	3
	Viewing documentation	3
	Accessing Brother Support (For Windows®)	5
	Control panel overview	6
	Status LED indications	8
2	Loading paper and documents	10
	Loading paper and print media	10
	Loading paper in the standard paper tray	10
	Loading paper in the multi-purpose tray (MP tray)	11
	Unprintable area	13
	Acceptable paper and other print media	14
	Recommended paper and print media	14
	Type and size of paper	15
	Handling and using special paper	17
	Loading documents	20
	Using the automatic document feeder (ADF)	20
	Using the scanner glass	21
3	General Setup	22
	Paper settings	22
	Paper Type	22
	Paper Size	22
	Tray Use in copy mode	23
	Tray Use in print mode	23
	Volume settings	24
	Beeper volume	24
	Automatic daylight savings time	24
	Ecology features	24
	Toner Save	24
	Sleep Time	25
	Turning off the scanner lamp	25
	LCD Contrast	25
	User Settings List.....	26
	Network Configuration List.....	26

4	Security features	27
	Secure Function Lock 2.0	27
	Setting the password for the administrator	27
	Changing the password for the administrator	28
	Setting up public user mode	28
	Setting up restricted users	29
	Turning Secure Function Lock on/off	29
	Switching Users	30

Section II Copy

5	Making copies	32
	How to copy	32
	Entering copy mode	32
	Making a single copy	32
	Making multiple copies	32
	Stop copying	32
	Copy options (temporary settings)	33
	Enlarging or reducing the image copied	33
	Improving copy quality	34
	Sorting copies using the ADF	34
	Changing text copy resolution	34
	Adjusting Contrast and Brightness	35
	Making N in 1 copies (page layout)	36
	Duplex (2-sided) copying	37
	Duplex Copy (long edge flip)	37
	Advanced Duplex Copy (short edge)	38
	Tray selection	39
	Out of memory message	39

Section III Direct printing

6	Printing data from a USB Flash memory drive or a digital camera supporting mass storage	42
	Supported file formats	42
	Creating a PRN or PostScript® 3™ file for direct printing	42
	Printing data directly from the USB Flash memory drive or a digital camera supporting mass storage	43
	Understanding the error messages	45

Section IV Software

7	Software and Network features	48
	How to read the HTML User's Guide	48
	Windows®	48
	Macintosh®	49

Section V Appendixes

A	Safety and legal	52
	Choosing a location	52
	To use the machine safely	53
	Important safety instructions	57
	Libtiff Copyright and License	59
	Trademarks	60
B	Options	61
	Optional paper tray (LT-5300)	61
	Memory board	61
	Installing extra memory	62
C	Troubleshooting and routine maintenance	63
	Troubleshooting	63
	If you are having difficulty with your machine	63
	Improving the print quality	68
	Error and maintenance messages	75
	Document jams	79
	Paper jams	80
	Routine maintenance	86
	Cleaning the outside of the machine	87
	Cleaning the scanner	87
	Cleaning the laser scanner window	88
	Cleaning the corona wire	90
	Cleaning the drum unit	91
	Replacing the consumable items	94
	Replacing a toner cartridge	95
	Replacing the drum unit	98
	Replacing periodic maintenance parts	100
	Machine Information	100
	Checking the Serial Number	100
	Checking the Page Counters	100
	Checking the remaining life of parts	101
	Reset	101
	How to reset	101
	Packing and shipping the machine	102

D	Menu and features	104
	On-screen programming.....	104
	Menu table.....	104
	Memory storage.....	104
	Menu keys	104
	How to access the menu mode	105
	Menu table	106
	Entering text	116
E	Specifications	118
	General.....	118
	Print media.....	120
	Copy	122
	Scan	123
	Print	124
	Interfaces	125
	Direct Print feature.....	126
	Computer requirements	127
	Consumable items	129
	Ethernet wired network.....	130
F	Glossary	132
G	Index	133



General

General information	2
Loading paper and documents	10
General Setup	22
Security features	27

Using the documentation

Thank you for buying a Brother machine! Reading the documentation will help you make the most of your machine.

Symbols and conventions used in the documentation

The following symbols and conventions are used throughout the documentation.

Bold	Bold style identifies keys on the machine control panel or computer screen.
<i>Italics</i>	Italicized style emphasizes an important point or refers you to a related topic.
Courier New	Courier New font identifies the messages shown on the LCD of the machine.

WARNING

Warnings tell you what to do to prevent possible personal injury.

CAUTION

Cautions specify procedures you must follow or avoid to prevent possible minor or severe injuries.

IMPORTANT

IMPORTANT describes procedures you must follow or avoid to prevent possible machine problems or damage to other objects.



Electrical Hazard icons alert you to a possible electrical shock.



Hot Surface icons warn you not to touch machine parts that are hot.



Notes tell you how you should respond to a situation that may arise or give tips about how the current operation works with other features.

Accessing the Software User's Guide and Network User's Guide

This User's Guide does not contain all the information about the machine such as how to use the advanced Printer, Scanner and Network features. When you are ready to learn detailed information about these operations, read the **Software User's Guide** and **Network User's Guide**.

Viewing documentation

Viewing documentation (Windows®)

To view the documentation, from the **Start** menu, point to **Brother, DCP-XXXX** (where XXXX is your model name) from the program group, and then click **User's Guides in HTML format**.

If you have not installed the software, you can find the documentation by following the instructions below:

- 1 Turn on your PC.
Insert the Brother CD-ROM labelled Windows® into your CD-ROM drive.

- 2 If the language selection screen appears, click your language.
- 3 If the model name screen appears, click your model name. The CD-ROM main menu will appear.



If this window does not appear, use Windows® Explorer to find and run the start.exe program from the root directory of the Brother CD-ROM.

- 4 Click **Documentation**.
- 5 Click the documentation you want to read:
 - HTML documents (3 manuals):
User's Guide for stand-alone operations, **Software User's Guide** and **Network User's Guide** in HTML format.
This format is recommended for viewing on your computer.
 - PDF documents (4 manuals):
User's Guide for stand-alone operations, **Software User's Guide**, **Network User's Guide** and **Quick Setup Guide**.
This format is recommended for printing the manuals. Click to go to the Brother Solutions Center, where you can view or download the PDF documents. (Internet access and PDF Reader software are required.)

How to find scanning instructions

There are several ways you can scan documents. You can find the instructions as follows:

Software User's Guide:

- Scanning a document using the TWAIN driver in Chapter 2
- Scanning a document using the WIA driver (Windows® XP/Windows Vista®) in Chapter 2
- Using ControlCenter3 in Chapter 3
- Network Scanning in Chapter 4

ScanSoft™ PaperPort™ 11SE with OCR How-to-Guides:

- The complete ScanSoft™ PaperPort™ 11SE with OCR How-to-Guides can be viewed from the Help selection in the ScanSoft™ PaperPort™ 11SE application.

Viewing documentation (Macintosh®)

- 1 Turn on your Macintosh®. Insert the Brother CD-ROM labelled Macintosh® into your CD-ROM drive.
- 2 The following window will appear.



- 3 Double-click the **Documentation** icon.
- 4 If the language selection screen appears, double-click your language.
- 5 Double-click the top page file to view the **User's Guide**, **Software User's Guide** and **Network User's Guide** in HTML format.
- 6 Click the documentation you want to read.
 - **User's Guide**
 - **Software User's Guide**
 - **Network User's Guide**



Note

The documents are also available in PDF format (4 manuals): **User's Guide** for stand-alone operations, **Software User's Guide**, **Network User's Guide** and **Quick Setup Guide**. The PDF format is recommended for printing the manuals.

Double-click **Brother Solutions Center** icon to go to the Brother Solutions Center, where you can view or download the PDF documents. (Internet access and PDF Reader software are required.)

How to find scanning instructions

There are several ways you can scan documents. You can find the instructions as follows:

Software User's Guide:

- Scanning in Chapter 9
- Using ControlCenter2 in Chapter 10
- Network Scanning in Chapter 11

Presto! PageManager User's Guide:

- The complete Presto! PageManager User's Guide can be viewed from the Help selection in the Presto! PageManager application.

Accessing Brother Support (For Windows®)

You can find all the contacts you will need, such as Web support (Brother Solutions Center).

- Click **Brother Support** on the main menu.

The following screen will appear:



- To access our web site (<http://www.brother.com>), click **Brother Home Page**.
- For the latest news and product support information (<http://solutions.brother.com>), click **Brother Solutions Center**.
- To visit our web site for original Brother Supplies (<http://www.brother.com/original/>), click **Supplies Information**.
- To return to the main page, click **Back** or if you have finished, click **Exit**.

Control panel overview



1 Status LED

The LED will flash and change colour depending on the machine status.

2 LCD

Displays messages to help you set up and use your machine.

3 Menu keys:

Menu

Lets you access the Menu to program your settings in this machine.

Clear/Back

Deletes entered data or lets you cancel the current setting.

OK

Lets you store your settings in the machine.

◀ or ▶

Press to scroll backwards or forwards through menu selections.

▲ or ▼

Press to scroll through the menus and options.

4 Numeric keys

Use these keys to enter text.

5 Stop/Exit

Stops an operation or exits from a menu.

6 Start

Lets you start making copies or scanning.

7 Copy keys:

Duplex

You can choose Duplex to copy on both sides of the paper.

Contrast/Quality

Lets you change the quality or contrast for the next copy.

Enlarge/Reduce

Reduces or enlarges copies.

Tray Select

Lets you change which tray will be used for the next copy.

Sort

Sorts multiple copies using the ADF.

N in 1

You can choose N in 1 to copy 2 or 4 pages onto one page.

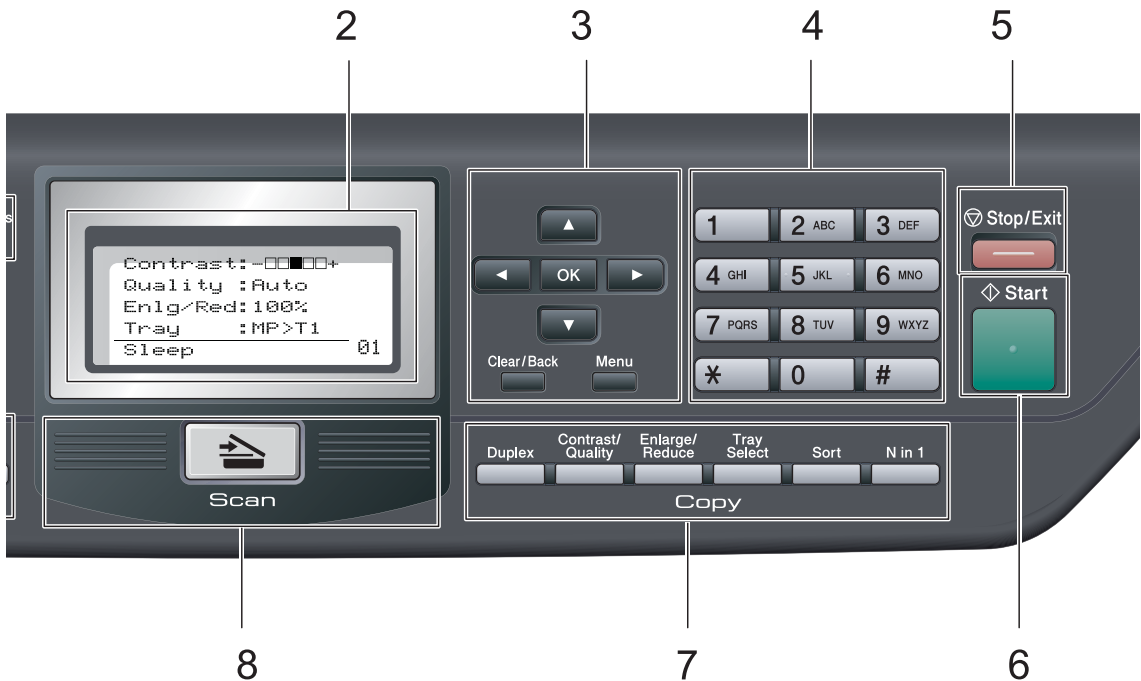

8 Scan

Puts the machine in Scan mode.
(For details about scanning, see the *Software User's Guide* on the CD-ROM.)

9 Print keys:

Secure/Direct

This key has two functions.

■ Secure

You can print data saved in memory when you enter your four-digit password. (For details about using the Secure key, see the *Software User's Guide* on the CD-ROM.)

When using Secure Function Lock, you can switch restricted users by holding down ◀ as you press **Secure/Direct**. (See *Secure Function Lock 2.0* on page 27.)

■ Direct

Lets you print data from a USB Flash memory drive. The Direct key will be active when a USB Flash memory drive is connected to the machine's USB direct interface. (See *Printing data directly from the USB Flash memory drive or a digital camera supporting mass storage* on page 43.)

Job Cancel





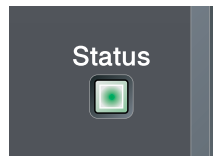

Cancels a programmed print job and clears it from the machine's memory.

To cancel multiple print jobs, hold down this key until the LCD shows Job Cancel (All).

Status LED indications

The **Status** LED (light emitting diode) will flash and change colour depending on the machine's status.

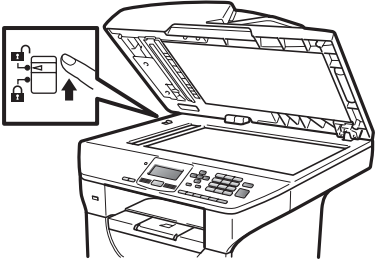

LED	Machine Status	Description
	Sleep Mode	The power switch is off or the machine is in Sleep mode.
 Green (blinking)	Warming Up	The machine is warming up for printing.
 Green	Ready	The machine is ready to print.
 Yellow (blinking)	Receiving Data	The machine is either receiving data from the computer, processing data in memory, or printing data.
 Yellow	Data Remaining in Memory	Print data remains in the machine memory.
 Red (blinking)	Service error	Follow the steps below. <ol style="list-style-type: none"> 1. Turn off the power switch. 2. Wait a few seconds, and then turn it back on and try to print again. If you cannot clear the error and you see the same service call indication after turning the machine back on, please call your Brother dealer for service.

 Red	Cover open	The front cover or fuser cover is open. Close the cover.
	Toner Life End	Replace the toner cartridge with a new one.
	Paper error	Put paper in the tray or clear the paper jam. Check the LCD message.
	Scan lock	Check that the scanner lock lever is released.
		
	Others	Check the LCD message.

**Note**

When the power switch is off or the machine is in Sleep mode, the LED is off.

2

Loading paper and documents

Loading paper and print media

The machine can feed paper from the standard paper tray, optional lower tray or multi-purpose tray.

When you put paper into the paper tray, note the following:

- If your application software supports paper size selection on the print menu, you can select it through the software. If your application software does not support it, you can set the paper size in the printer driver or by using the control panel buttons.

Loading paper in the standard paper tray

Printing on plain paper, thin paper, recycled paper or transparencies from the paper tray

- 1 Pull the paper tray completely out of the machine.

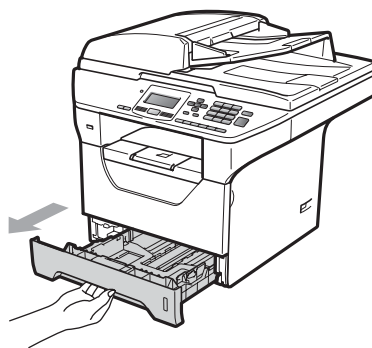

- 2 While pressing the blue paper-guide release lever (1), slide the paper guides to fit the paper size you are loading in the tray. Make sure that the guides are firmly in the slots.

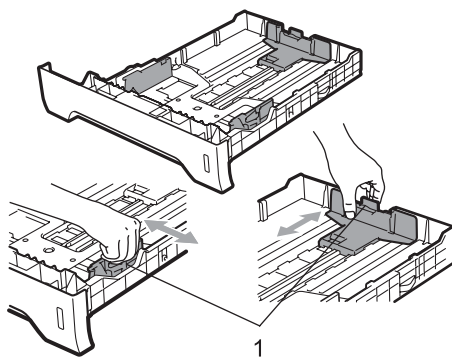

- 3 Fan the stack of paper well to avoid paper jams and misfeeds.



- 4 Put paper in the tray, and make sure that the paper is below the maximum paper mark (1). The side to be printed on must be face down.

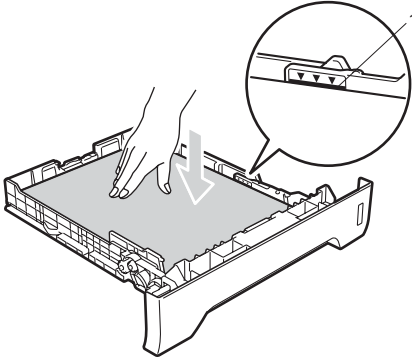

! IMPORTANT

Make sure the paper guides touch the sides of the paper.

- 5 Put the paper tray firmly back in the machine. Make sure that it is completely inserted into the machine.
- 6 Fold out the support flap (1) to prevent paper from sliding off the face-down output tray.

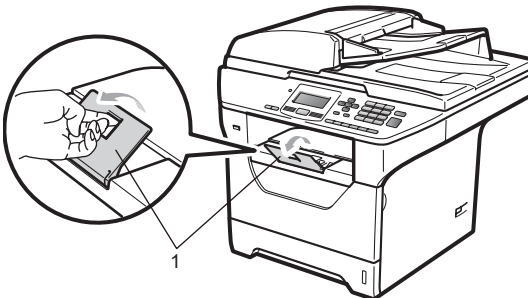

Loading paper in the multi-purpose tray (MP tray)

You can load up to 3 envelopes or special print media in the MP tray or up to 50 sheets of plain paper. Use this tray to print or copy on thick paper, bond paper, envelopes, labels or transparencies.

Printing on thick paper, bond paper, envelopes, labels and transparencies

Before loading, press the corners and sides of the envelopes to make them as flat as possible.

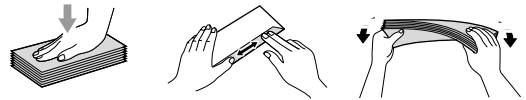

When the back output tray is pulled down, the machine has a straight paper path from the MP tray through to the back of the machine. Use this paper feed and output method when you want to print on thick paper, bond paper, envelopes, labels or transparencies.

! IMPORTANT

Remove each printed sheet or envelope immediately to prevent a paper jam.

- 1 Open the back cover (back output tray).

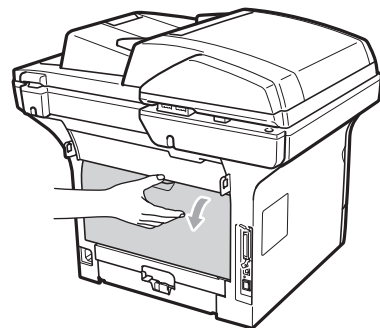

- 2 Open the MP tray and lower it gently.

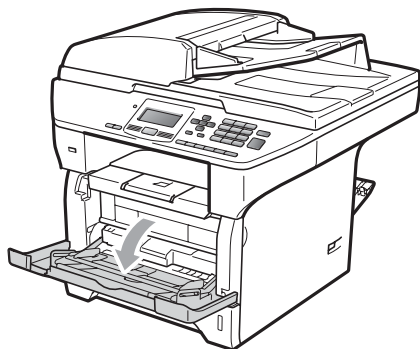

- 3 Pull out the MP tray support (1) and unfold the flap (2).

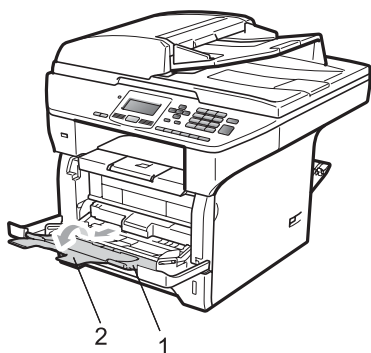

- 4 While pressing the paper side guide release lever, slide the paper guides to fit the width of the paper that you are going to use.

! IMPORTANT

Make sure the paper guides touch the sides of the paper.

- 5 Put the envelopes (up to 3), thick paper, labels or transparencies in the MP tray with the top edge first and the print side face up. Make sure that the paper stays under the maximum paper mark (▼).

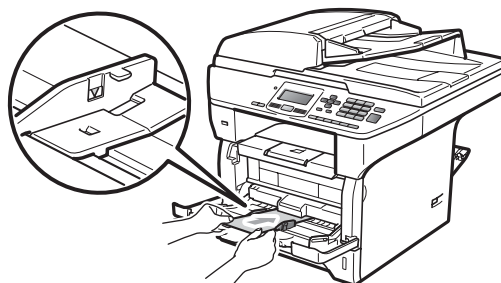

Unprintable area

Unprintable area for copies

The figures show unprintable areas.

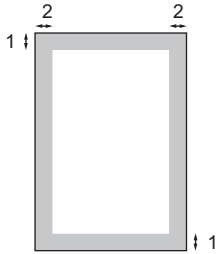

Document Size	Top (1) Bottom (1)	Left (2) Right (2)
Letter	3 mm	4 mm
A4	3 mm	2 mm



Note

This unprintable area shown above is for a single copy or a 1 in 1 copy using A4 size paper. The unprintable area changes with the paper size.

Unprintable area when printing from a computer

When using the printer driver the printable area is smaller than the paper size, as shown below.

Portrait

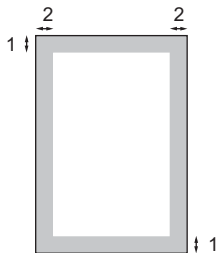

Landscape

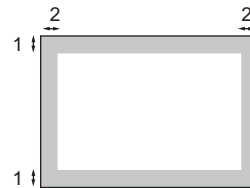

		Windows® printer driver and Macintosh® printer driver	BRScript Driver for Windows® and Macintosh®
Portrait	1	4.23 mm	4.23 mm
	2	6.35 mm	4.23 mm
Landscape	1	4.23 mm	4.23 mm
	2	5.08 mm	4.23 mm



Note

The unprintable area shown above is for A4 size paper. The unprintable area changes with the paper size.

Acceptable paper and other print media

Print quality may vary according to the type of paper you are using.

You can use the following types of print media: thin paper, plain paper, thick paper, bond paper, recycled paper, transparencies, labels or envelopes.

For best results, follow the instructions below:

- Use paper made for plain paper copying.
- Use paper that is 60 to 105 g/m².
- Use labels and transparencies which are designed for use in laser machines.
- DO not put different types of paper in the paper tray at the same time because it may cause paper jams or misfeeds.
- For correct printing, you must choose the same paper size from your software application as the paper in the tray.
- Avoid touching the printed surface of the paper immediately after printing.
- When you use transparencies remove each sheet immediately to prevent smudging or paper jams.
- Use long grain paper with a neutral Ph value, and a moisture content of approx. 5%.

Recommended paper and print media

To get the best print quality, we suggest using the following paper.

Paper Type	Item
Plain paper	Xerox Premier TCF 80 g/m ²
	Xerox Business 80 g/m ²
Recycled Paper	Xerox Recycled Supreme 80 g/m ²
Transparency	3M CG3300
Labels	Avery laser label L7163
Envelope	Antalis River series (DL)

Type and size of paper

The machine loads paper from the installed standard paper tray, optional lower tray or multi-purpose tray.

Standard paper tray

Since the standard paper tray is a universal type, you can use any of the paper sizes (one paper type and size at a time) listed in the table in *Paper capacity of the paper trays* on page 16. The standard paper tray can hold up to 250 sheets of Letter/A4 size paper (80 g/m²). Paper can be loaded up to the maximum paper mark on the sliding paper width guide.

Multi-purpose tray (MP tray)

The MP tray can hold up to 50 sheets of plain paper (60 to 163 g/m²) or up to 3 envelopes. Paper can be loaded up to the maximum paper mark on the sliding paper width guide.

Optional lower tray (LT-5300)

The optional lower tray can hold up to 250 sheets of Letter/A4 size paper (80 g/m²). Paper can be loaded up to the top line of the maximum paper mark on the sliding paper width guide.

The name for the paper trays in the printer driver in this Guide are as follows:

Tray and optional unit	Name
Standard paper tray	Tray 1
Optional lower tray	Tray 2
Multi-purpose tray	MP tray

Paper capacity of the paper trays

	Paper size	Paper types	No. of sheets
Paper Tray (Tray #1)	A4, Letter, Executive, A5, A5 (Long Edge), A6, B5 and B6.	Plain paper, Thin paper and Recycled paper	up to 250 [80 g/m ²]
		Transparency	up to 10
Multi-purpose tray (MP tray)	Width: 69.8 to 216 mm Length: 116 to 406.4 mm	Plain paper, Thin paper, Thick paper, Bond paper, Recycled paper, Envelopes and Labels.	up to 50 [80 g/m ²] up to 3 (envelopes)
		Transparency	up to 10
Paper Tray (Tray #2)	A4, Letter, Executive, A5, B5 and B6.	Plain paper, Thin paper and Recycled paper	up to 250 [80 g/m ²]

Recommended paper specifications

The following paper specifications are suitable for this machine.

Basis weight	75-90 g/m ²
Thickness	80-110 μm
Roughness	Higher than 20 sec.
Stiffness	90-150 cm ³ /100
Grain direction	Long grain
Volume resistivity	10e ⁹ -10e ¹¹ ohm
Surface resistivity	10e ⁹ -10e ¹² ohm-cm
Filler	CaCO ₃ (Neutral)
Ash content	Below 23 wt%
Brightness	Higher than 80%
Opacity	Higher than 85%

Handling and using special paper

The machine is designed to work well with most types of xerographic and bond paper. However, some paper variables may have an effect on print quality or handling reliability. Always test samples of paper before purchasing to ensure desirable performance. Store paper in its original packaging and keep it sealed. Keep the paper flat and away from moisture, direct sunlight and heat.

Some important guidelines when selecting paper are:

- Do not use inkjet paper because it may cause a paper jam or damage your machine.
- Preprinted paper must use ink that can withstand the temperature of the machine's fusing process (200 degrees centigrade).
- If you use bond paper, paper having a rough surface or paper that is wrinkled or creased, the paper may exhibit degraded performance.

Types of paper to avoid

! IMPORTANT

Some types of paper may not perform well or may cause damage to your machine.

DO NOT use paper:

- that is highly textured
- that is extremely smooth or shiny
- that is curled or warped

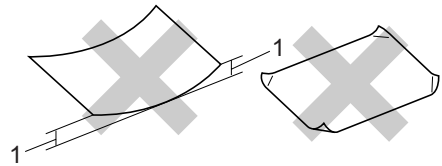

1 2mm

- that is coated or has a chemical finish
- that is damaged, creased or folded
- that exceeds the recommended weight specification in this guide
- with tabs or staples
- with letterheads using low temperature dyes or thermography
- that is multipart or carbonless
- that is designed for inkjet printing

If you use any of the types of paper listed above, they may damage your machine. This damage is not covered under any Brother warranty or service agreement.

Envelopes

Most envelopes will be suitable for your machine. However, some envelopes may have feed and print-quality problems because of the way they have been made. A suitable envelope should have edges with straight, well-creased folds and the leading edge should not be thicker than two sheets of paper. The envelope should lie flat and not be of baggy or flimsy construction. You should buy quality envelopes from a supplier who understands that you will be using the envelopes in a laser machine.

Envelopes can only be fed from the MP tray. Do not print envelopes using duplex printing. We recommend that you print a test envelope to make sure the print results are what you want before you print or purchase a large quantity of envelopes.

Check the following:

- Envelopes should have a lengthwise sealing flap.
- The sealing flaps should be folded crisply and correctly (irregularly cut or folded envelopes may cause paper jams).
- Envelopes should consist of two layers of paper in the area circled in figure below.

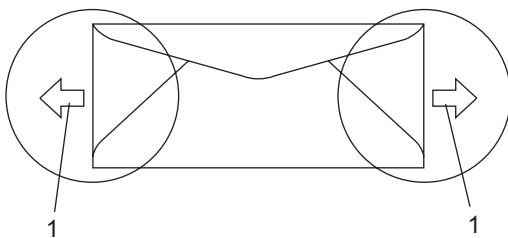

1 Feeding direction

- Envelope joints that are sealed by the manufacturer should be secure.
- We recommend that you do not print within 15 mm of the edges of envelopes.

Types of envelopes to avoid

! IMPORTANT

DO NOT use envelopes:

- that are damaged, curled, wrinkled or an unusual shape
- that are extremely shiny or textured
- with clasps, staples, snaps or tie strings
- with self-adhesive closures
- that are of a baggy construction
- that are not sharply creased
- that are embossed (have raised writing on them)
- that were previously printed by a laser machine
- that are pre-printed on the inside
- that cannot be arranged neatly when stacked
- that are made of paper that weighs more than the paper weight specifications for the machine
- with edges that are not straight or consistently square
- with windows, holes, cut-outs or perforations
- with glue on surface as shown in figure below

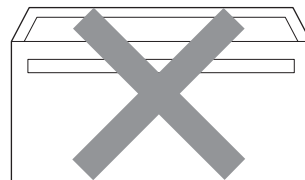

- with double flaps as shown in figure below

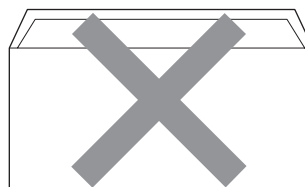

- with sealing flaps that have not been folded at purchase
- with sealing flaps as shown in figure below

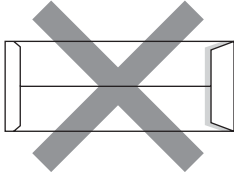

- with each side folded as shown in figure below

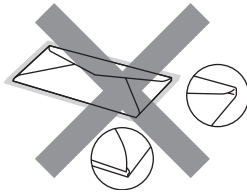

If you use any of the types of envelopes listed above, they may damage your machine. This damage is not covered under any Brother warranty or service agreement.

Occasionally you may experience paper feed problems caused by the thickness, size and flap shape of the envelopes you are using.

Labels

The machine will print on most types of labels designed for use with a laser machine. Labels should have an adhesive that is acrylic-based since this material is more stable at the high temperatures in the fuser unit. Adhesives should not come in contact with any part of the machine, because the label stock may stick to the drum unit or rollers and cause jams and print quality problems. No adhesive should be exposed between the labels. Labels should be arranged so that they cover the entire length and width of the sheet. Using labels with spaces may result in labels peeling off and causing serious jams or print problems.

All labels used in this machine must be able to withstand a temperature of 392 degrees Fahrenheit (200 degrees centigrade) for a period of 0.1 seconds.

Label sheets should not exceed the paper weight specifications described in this User's Guide. Labels exceeding this specification may not feed or print correctly and may cause damage to your machine.

Labels can be fed from the MP Tray only.

Types of labels to avoid

Do not use labels that are damaged, curled, wrinkled or an unusual shape.

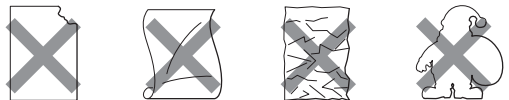

! IMPORTANT

DO NOT feed part used label sheets. The exposed carrier sheet will damage your machine.

Loading documents

Using the automatic document feeder (ADF)

The ADF can hold up to 50 pages and feeds each sheet individually. Use standard 80 g/m² paper and always fan the pages before putting them in the ADF.

Recommended environment

Temperature: 20 to 30° C
 Humidity: 50% - 70%
 Paper: Xerox Premier TCF 80 g/m² or Xerox Business 80 g/m²

! IMPORTANT

- DO NOT leave thick documents on the scanner glass. If you do this, the ADF may jam.
- DO NOT use paper that is curled, wrinkled, folded, ripped, stapled, paper-clipped, pasted or taped.
- DO NOT use cardboard, newspaper or fabric.
- To avoid damaging your machine while using the ADF, DO NOT pull on the document while it is feeding.



Note

To scan non-standard documents see *Using the scanner glass* on page 21.

- Make sure documents written with ink are completely dry.

- 1 Unfold the ADF document output support flap (1) and the ADF support flap (2).

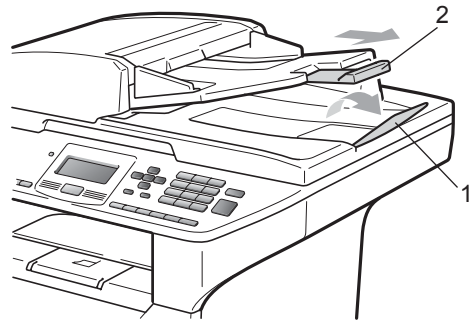

- 2 Fan the pages well.
- 3 Place your document **face up, top edge first** in the ADF until you feel it touch the feed roller.
- 4 Adjust the paper guides (1) to fit the width of your document.

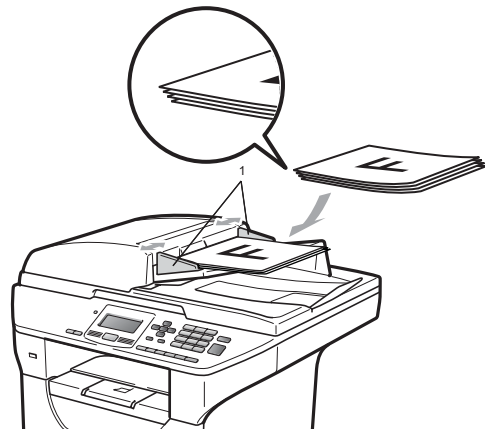

Using the scanner glass

You can use the scanner glass to copy or scan pages of a book or one page at a time. Documents can be up to 215.9 mm wide and 355.6 mm long.



Note

To use the scanner glass, the ADF must be empty.

- 1 Lift the document cover.
- 2 Using the document guidelines on the left, centre the document face down on the scanner glass.

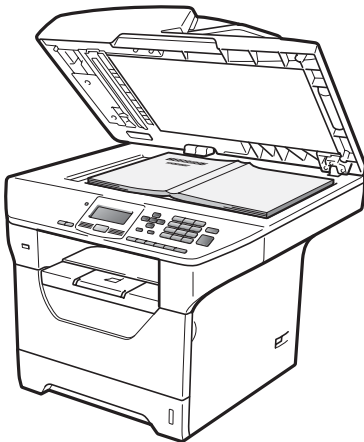
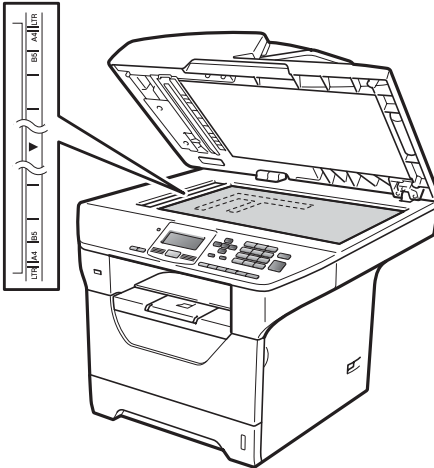

- 3 Close the document cover.

! IMPORTANT

If the document is a book or is thick do not slam the cover or press on it.

3

General Setup

Paper settings

Paper Type

Set up the machine for the type of paper you are using. This will give you the best print quality.

- 1 Do one of the following:
 - To set the paper type for the MP Tray press **Menu, 1, 1, 1, 1**.
 - To set the paper type for Tray#1 press **Menu, 1, 1, 1, 2**.
 - To set the paper type for Tray#2 ¹ press **Menu, 1, 1, 1, 3** if you installed the optional tray.

¹ Tray#2 Only or T2 appears only if the optional tray is installed.

- 2 Press **▲** or **▼** to choose **Thin, Plain, Thick, Thicker, Transparency Or Recycled Paper**. Press **OK**.

- 3 Press **Stop/Exit**.



Note

You can choose **Transparency** for Tray #1 and the MP Tray.

Paper Size

You can use ten sizes of paper for printing copies: A4, Letter, Legal, Executive, A5, A5 L, A6, B5, B6 and Folio.

When you change the size of paper in the tray, you will also need to change the setting for paper size at the same time so your machine can fit the document.

- 1 Do one of the following:
 - To set the paper size for the MP Tray press **Menu, 1, 1, 2, 1**.
 - To set the paper size for Tray#1 press **Menu, 1, 1, 2, 2**.
 - To set the paper size for Tray#2 ¹ press **Menu, 1, 1, 2, 3** if you installed the optional tray.

¹ Tray#2 Only or T2 appears only if the optional tray is installed.

- 2 Press **▲** or **▼** to choose **A4, Letter, Legal, Executive, A5, A5 L, A6, B5, B6, Folio Or Any**. Press **OK**.

- 3 Press **Stop/Exit**.



Note

- **Legal, Folio** and **Any** size appears only when you choose the MP tray.
- If you choose **Any** for the MP Tray Paper Size: You must choose **MP Only** for the Tray Use setting. You cannot use the **Any** Paper Size selection for the MP tray when making N in 1 copies. You must choose one of the other available Paper Size selections for the MP tray.
- **A5 L** and **A6** size are not available for the optional Tray#2.

- If you chose **Transparency** for the Paper Type you will only be able to choose **Letter**, **Legal**, **Folio** or **A4** size paper in step ②.

Tray Use in copy mode

You can change the priority tray that the machine will use for printing copies.

When you choose **Tray#1 Only**, **MP Only** or **Tray#2 Only**¹, the machine pulls the paper only from that tray. If the selected tray is out of paper, **No Paper** will appear on the LCD. Insert the paper in the empty tray.

To change the tray setting follow the instructions below:

- 1 Press **Menu**, **1**, **4**, **1**.
- 2 Press **▲** or **▼** to choose **Tray#1 Only**, **Tray#2 Only**¹, **MP Only**, **MP>T1>T2**¹ or **T1>T2**¹>**MP**. Press **OK**.

¹ **Tray#2 Only** or **T2** appears only if the optional tray is installed.

- 3 Press **Stop/Exit**.



Note

- When loading the documents in the ADF and **MP>T1>T2** or **T1>T2>MP** is chosen, the machine looks for the tray with the most suitable paper and pulls paper from that tray. If no tray has suitable paper, the machine pulls paper from the higher priority tray.
- When using the scanner glass, your document is copied from the higher priority tray even if more suitable paper is in another paper tray.

Tray Use in print mode

You can change the default tray the machine will use for printing from your computer.

- 1 Press **Menu**, **1**, **4**, **2**.
- 2 Press **▲** or **▼** to choose **Tray#1 Only**, **Tray#2 Only**¹, **MP Only**, **MP>T1>T2**¹ or **T1>T2**¹>**MP**. Press **OK**.

¹ **Tray#2 Only** or **T2** appears only if the optional tray is installed.

- 3 Press **Stop/Exit**.



Note

- The setting in the printer driver will take priority over the setting made on the control panel.
- If the control panel is set to **Tray#1 Only**, **MP Only** or **Tray#2 Only**¹ and you choose **Auto Select** in the printer driver, the machine pulls the paper from that tray.

¹ **Tray#2 Only** appears only if the optional tray is installed.

Volume settings

Beeper volume

When the beeper is on, the machine will beep when you press a key or make a mistake. You can choose a range of volume levels, from High to Off.

- 1 Press **Menu**, **1**, **2**.
- 2 Press **▲** or **▼** to choose *Off*, *Low*, *Med* or *High*. Press **OK**.
- 3 Press **Stop/Exit**.

Automatic daylight savings time

You can set the machine to change automatically for Daylight Savings Time. It will set itself forward one hour in the Spring, and back one hour in the Autumn.

- 1 Press **Menu 6**, **2**.
- 2 Press **▲** or **▼** to choose *On* or *Off*. Press **OK**.
- 3 Press **Stop/Exit**.

Ecology features

Toner Save

You can save toner using this feature. When you set Toner Save to *On*, prints appear lighter. The default setting is *Off*.

- 1 Press **Menu**, **1**, **3**, **1**.
- 2 Press **▲** or **▼** to choose *On* or *Off*. Press **OK**.
- 3 Press **Stop/Exit**.



Note

We do not recommend Toner Save for printing Photo or Greyscale images.

Sleep Time

The Sleep Time setting can reduce power consumption by turning off the fuser while the machine is idle.

You can choose how long the machine must be idle before it goes into sleep mode. When the machine receives computer data or makes a copy, the timer will be reset. The default setting is 005 minutes.

While the machine is in sleep mode the LCD will display *Sleep*. When printing or copying in sleep mode, there will be a short delay while the fuser warms up.

- 1 Press **Menu 1, 3, 2**.
- 2 Enter the length of time the machine is idle before entering sleep mode. Press **OK**.
- 3 Press **Stop/Exit**.



Note

To turn *off* sleep mode, press **Secure/Direct** and **Job Cancel** at the same time in step 2. Press **▲** or **▼** to choose *Off*. Press **OK**.

Turning off the scanner lamp

The scanner lamp stays on for 16 hours before automatically switching off to preserve the life of the lamp and reduce power consumption.

To turn the scanner lamp off manually press the **◀** and **▶** keys simultaneously. The scanner lamp will remain turned off until the next time you use the scanning feature.



Note

Turning the lamp off regularly will reduce the lamp's life.

LCD Contrast

You can change the contrast to make the LCD look lighter or darker.

- 1 Press **Menu, 1, 5**.
- 2 Press **◀** to make the LCD lighter. Or, press **▶** to make the LCD darker. Press **OK**.
- 3 Press **Stop/Exit**.

User Settings List

You can print a list of the settings you programmed.

- 1 Press **Menu, 6, 5**.
- 2 Press **Start**.

Network Configuration List

The Network Configuration List is a report listing the current network configuration including the network print server settings.



Note

Node name: Node name appears in the Network Configuration List. The default node name is "BRNXXXXXXXXXXXXX".

- 1 Press **Menu, 6, 6**.
- 2 Press **Start**.

Secure Function Lock 2.0

Secure Function Lock lets you restrict Public access to the following machine functions:

- PC Print
- USB Direct Print
- Copy
- Scan

This feature also prevents users from changing the Default settings of the machine by limiting access to the Menu settings.

Before using the security features you must first enter an administrator password.

Access to restricted operations can be enabled by creating a restricted user. Restricted users must enter a user password to use the machine.

Make a careful note of your password. If you forget it you will have to reset the password stored in the machine. For information about how to reset the password call your Brother dealer for service.



Note

- Secure Function Lock can be set manually at the control panel or by using Web Based Management. We recommend using Web Based Management to configure this feature. For more information, see the *Network User's Guide* on the CD-ROM.
- Only administrators can set limitations and make changes for each user.
- When Print is disabled, PC print jobs will be lost without notification.

Setting the password for the administrator

The password you set in these steps is for the administrator. This password is used to set up users and to turn Secure Function Lock on or off. (See *Setting up restricted users* on page 29 and *Turning Secure Function Lock on/off* on page 29.)

- 1 Press **Menu**, **1**, **6**.
- 2 Enter a four-digit number for the password using numbers 0-9. Press **OK**.
- 3 Re-enter the password when the LCD shows *Verify:.* Press **OK**.
- 4 Press **Stop/Exit**.

Changing the password for the administrator

- 1 Press **Menu**, **1**, **6**.
- 2 Press **▲** or **▼** to choose `Set Password`. Press **OK**.
- 3 Enter the registered four-digit password. Press **OK**.
- 4 Enter a four-digit number for the new password. Press **OK**.
- 5 If the LCD shows `Verify`: re-enter the new password. Press **OK**.
- 6 Press **Stop/Exit**.

Setting up public user mode

Public user mode restricts the functions that are available for public users. Public users do not need to enter a password to access the features made available through this setting. You can set up one Public user.

- 1 Press **Menu**, **1**, **6**.
- 2 Press **▲** or **▼** to choose `Setup ID`. Press **OK**.
- 3 Enter the administrator password. Press **OK**.
- 4 Press **▲** or **▼** to choose `Public`. Press **OK**.
- 5 Press **▲** or **▼** to choose `Enable` or `Disable` for `Copy`. Press **OK**.
After you have set `Copy`, repeat this step for `Scan`, `USB Direct` and `PC Print`.
When you have finished changing settings, press **▲** or **▼** to choose `Exit` and press **OK**.
- 6 Press **Stop/Exit**.

Setting up restricted users

You can set up users with restrictions and a password for functions that are available to them. You can set up more advanced restrictions, such as by page count or PC user login name, through Web Based Management. (For more information, see the *Network User's Guide* on the CD-ROM.) You can set up to 25 restricted users with restrictions and a password.

- 1 Press **Menu**, **1**, **6**.
- 2 Press **▲** or **▼** to choose `Setup ID`. Press **OK**.
- 3 Enter the administrator password. Press **OK**.
- 4 Press **▲** or **▼** to choose `User01`. Press **OK**.
- 5 Use the numeric keys to enter the user name. (See *Entering text* on page 116.) Press **OK**.
- 6 Enter a four-digit password for the user. Press **OK**.
- 7 Press **▲** or **▼** to choose `Enable` or `Disable` for `Copy`. Press **OK**.
After you have set `Copy`, repeat this step for `Scan`, `USB Direct` and `PC Print`.
When you have finished changing settings, press **▲** or **▼** to choose `Exit` and press **OK**.
- 8 Repeat steps 4 to 7 for entering each additional user and password.
- 9 Press **Stop/Exit**.



Note

You cannot use the same name as another user's name.

Turning Secure Function Lock on/off

If you enter the wrong password, the LCD will show `Wrong Password`. Re-enter the correct password.

Turning Secure Function Lock on

- 1 Press **Menu**, **1**, **6**.
- 2 Press **▲** or **▼** to choose `Lock Off-On`. Press **OK**.
- 3 Enter your four-digit administrator password. Press **OK**.

Turning Secure Function Lock off

- 1 Press **Menu**, **1**, **6**.
- 2 Press **▲** or **▼** to choose `Lock On-Off`. Press **OK**.
- 3 Enter your four-digit administrator password. Press **OK**.

Switching Users

This setting allows you to switch between registered restricted users or Public mode when Secure Function Lock is turned on.

Changing to the restricted user Mode

- 1 Hold down ◀ as you press **Secure/Direct**.
- 2 Press ▲ or ▼ to choose your name.
Press **OK**.
- 3 Enter your four-digit password.
Press **OK**.



Note

- If you press the Scan mode key when it is restricted, *Access Denied* will appear on the LCD and then the machine will ask your name. If you are a restricted user with access to Scan mode, press ▲ or ▼ to choose your name and enter your four-digit password.
 - After a restricted user has finished using the machine, it will return to the Public mode within one minute.
-



Copy

Making copies

32

5

Making copies

How to copy

Entering copy mode

```
1 — Contrast: -□□■□□+
2 — Quality :Auto
3 — Enlg/Red:100%
4 — Tray   :MP>T1
   Press ▲▼ or Start 01 — 5
```

```
Quality :Auto
Enlg/Red:100%
Tray     :MP>T1
6 — Bright : -□□■□□+
   Select ◀▶ & OK 01
```

- 1 **Contrast**
- 2 **Quality**
- 3 **Copy ratio**
- 4 **Tray selection**
- 5 **Number of copies**
- 6 **Brightness**

Making a single copy

- 1 Load your document.
- 2 Press **Start**.

Making multiple copies

- 1 Load your document.
- 2 Use the dial pad to enter the number of copies (up to 99).
- 3 Press **Start**.



Note

To sort your copies, see *Sorting copies using the ADF* on page 34.

Stop copying

To stop copying, press **Stop/Exit**.

Copy options (temporary settings)

When you want to quickly change the copy settings temporarily for the next copy, use the temporary **Copy** keys. You can use different combinations.

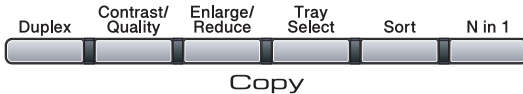

The machine returns to its default settings one minute after copying.

Enlarging or reducing the image copied

You can choose the following enlargement or reduction ratios:

Press 	100%*
	97% LTR→A4
	94% A4→LTR
	91% Full Page
	85% LTR→EXE
	83%
	78%
	70% A4→A5
	50%
	Custom (25-400%)
	Auto
	200%
	141% A5→A4
104% EXE→LTR	

* The factory setting is shown in Bold with an asterisk.

When set to *Auto*, the machine calculates the reduction ratio that best fits the paper size the paper tray is set to. (See *Paper Size* on page 22.)

Auto is only available when using the ADF.

Custom (25-400%) allows you to enter a ratio from 25% to 400%.

To enlarge or reduce the next copy follow the instructions below:

- 1 Load your document.
- 2 Use the dial pad to enter the number of copies (up to 99).
- 3 Press **Enlarge/Reduce**. Press **▶**.
- 4 Do one of the following:
 - Press **▲** or **▼** to choose the enlargement or reduction ratio you want.
Press **OK**.
 - Press **▲** or **▼** to choose *Custom* (25-400%).
Press **OK**.
Use the dial pad to enter an enlargement or reduction ratio from 25% to 400%. (For example, press **5 3** to enter 53%.)
Press **OK**.
- 5 Press **Start**.

Note
Page Layout Options 2 in 1(P), 2 in 1(L), 4 in 1(P) or 4 in 1(L) are *not* available with Enlarge/Reduce.

Improving copy quality

You can choose from a range of quality settings. The default setting is *Auto*.

■ Auto

Auto is the recommended mode for ordinary printouts. Suitable for documents that contain both text and photographs.

■ Text

Suitable for documents containing only text.

■ Photo

Suitable for copying photographs.

To *temporarily* change the quality setting, follow the steps below:

- 1 Load your document.
- 2 Use the dial pad to enter the number of copies (up to 99).
- 3 Press **Contrast/Quality**. Press ▲ or ▼ to choose *Quality*. Press **OK**.
- 4 Press ◀ or ▶ to choose *Auto*, *Text* or *Photo*. Press **OK**.
- 5 Press **Start**.

To change the *default* setting, follow the steps below:

- 1 Press **Menu, 2, 1**.
- 2 Press ▲ or ▼ to choose the copy quality. Press **OK**.
- 3 Press **Stop/Exit**.

Sorting copies using the ADF

You can sort multiple copies. Pages will be stacked in the order 1 2 3, 1 2 3, 1 2 3, and so on.

- 1 Load your document in the ADF.
- 2 Use the dial pad to enter the number of copies (up to 99).
- 3 Press **Sort**.
- 4 Press **Start**.

Changing text copy resolution

You can change the text copy resolution to 1200x600dpi if you are using the scanner glass and have chosen *Text* as the Copy Quality and an enlargement or reduction ratio of 100%. The default setting is 600dpi.

- 1 Put your document on the scanner glass.
- 2 Press **Menu, 2, 2**.
- 3 Press ▲ or ▼ to choose the text copy resolution. Press **OK**.
- 4 Press **Stop/Exit**.

Adjusting Contrast and Brightness

Contrast

Adjust the contrast to help an image look sharper and more vivid.

To *temporarily* change the contrast setting, follow the steps below:

- 1 Load your document.
- 2 Use the dial pad to enter the number of copies (up to 99).
- 3 Press **Contrast/Quality**.
Press ▲ or ▼ to choose **Contrast**.
Press **OK**.

```

Contrast:-□□■□□+▶
Quality :Auto
Enlg/Red:100%
Tray    :MP>T1
Select ◀▶ & OK      01
  
```

- 4 Press ◀ or ▶ to increase or decrease the contrast.
Press **OK**.
- 5 Press **Start**.

To change the *default* setting follow the steps below:

- 1 Press **Menu, 2, 4**.
- 2 Press ◀ or ▶ to increase or decrease the contrast. Press **OK**.
- 3 Press **Stop/Exit**.

Brightness

Adjust the copy brightness to make copies darker or lighter.

To *temporarily* change the copy brightness setting, follow the steps below:

- 1 Load your document.
- 2 Use the dial pad to enter the number of copies (up to 99).
- 3 Press ▲ or ▼ to choose **Bright**.

```

Quality :Auto
Enlg/Red:100%
Tray    :MP>T1
Bright  :-□□■□□+▶
Select ◀▶ & OK      01
  
```

- 4 Press ▶ to make a lighter copy or press ◀ to make a darker copy.
Press **OK**.
- 5 Press **Start**.

To change the *default* setting follow the steps below:

- 1 Press **Menu, 2, 3**.
- 2 Press ▶ to make a lighter copy or press ◀ to make a darker copy.
Press **OK**.
- 3 Press **Stop/Exit**.

Making N in 1 copies (page layout)

You can reduce the amount of paper used when copying by using the N in 1 copy feature. This allows you to copy two or four pages onto one page, which lets you save paper.

! IMPORTANT

- Please make sure the paper size is set to Letter, A4, Legal¹ or Folio¹.
- (P) means Portrait and (L) means Landscape.
- You cannot use the Enlarge/Reduce setting with the N in 1 feature.

¹ You can choose Legal and Folio for MP Tray only.

- 1 Load your document.
- 2 Use the dial pad to enter the number of copies (up to 99).
- 3 Press **N in 1**.
- 4 Press **▲** or **▼** to choose 2 in 1 (P), 2 in 1 (L), 4 in 1 (P), 4 in 1 (L) or Off (1 in 1). Press **OK**.
- 5 Press **Start** to scan the page. If you placed the document in the ADF, the machine scans the pages and starts printing. **If you are using the scanner glass, go to step 6.**
- 6 After the machine scans the page, press **1** to scan the next page.

Flatbed Copy:
 Next Page?
 ▲ 1.Yes
 ▼ 2.No
 Select ▲▼ or OK
- 7 Put the next page on the scanner glass. Press **OK**.

Repeat steps 6 and 7 for each page of the layout.

- 8 After all the pages have been scanned, press **2** in step 6 to finish.

If you are copying from the ADF:

Insert your document face up in the direction shown below:

■ 2 in 1 (P)



■ 2 in 1 (L)

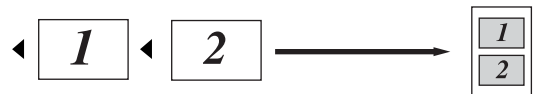

■ 4 in 1 (P)



■ 4 in 1 (L)

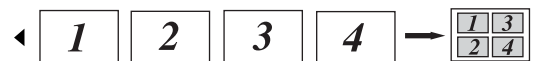

If you are copying from the scanner glass:

Insert your document face down in the direction shown below:

■ 2 in 1 (P)



■ 2 in 1 (L)

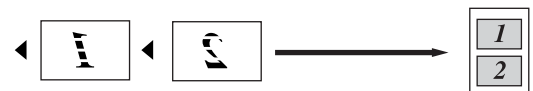

■ 4 in 1 (P)



■ 4 in 1 (L)



Duplex (2-sided) copying

If you want to use the duplex copy feature, load your document in the ADF.

If you get an *Out of Memory* message while you are making duplex copies, try installing extra memory. (See *Out of memory message* on page 39.)

Duplex Copy (long edge flip)

■ 1 sided → 2 sided

Portrait

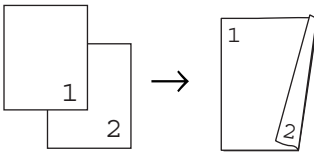

Landscape

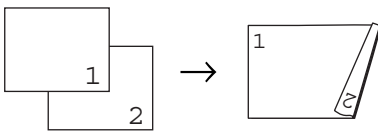

■ 2 sided → 2 sided

Portrait

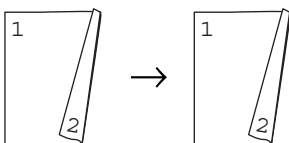

Landscape

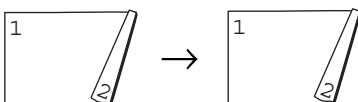

■ 2 sided → 1 sided

Portrait

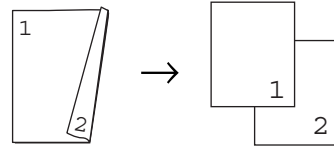

Landscape

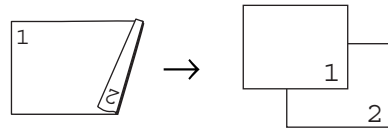

- 1 Load your document.
- 2 Enter the number of copies (up to 99) using the dial pad.
- 3 Press **Duplex** and ▲ or ▼ to choose 1sided → 2sided, 2sided → 2sided or 2sided → 1sided.

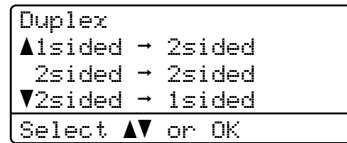

Press **OK**.

- 4 Press **Start** to copy the document.



Note

Duplex copy using a 2-sided legal size document is not available.

Advanced Duplex Copy (short edge)

■ Advanced 2 sided → 1 sided

Portrait

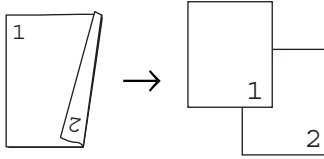

Landscape

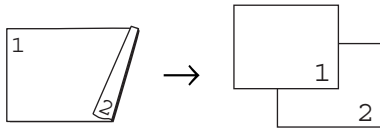

■ Advanced 1 sided → 2 sided

Portrait

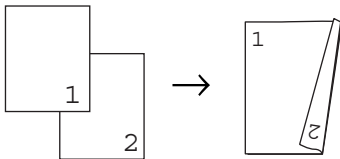

Landscape

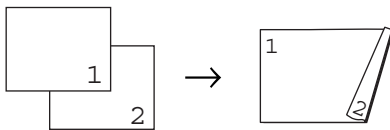

- 1 Load your document.
- 2 Enter the number of copies (up to 99) using the dial pad.
- 3 Press **Duplex** and ▲ or ▼ to choose Advanced.

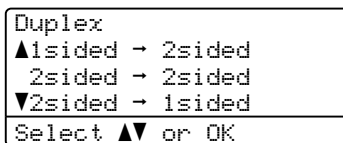

Press **OK**.

- 4 Press ▲ or ▼ to choose 2sided → 1sided or 1sided → 2sided.

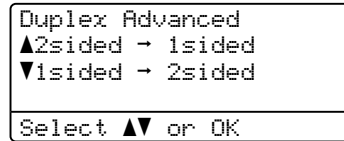

Press **OK**.

- 5 Press **Start** to copy the document.



Note

Duplex copy using a 2-sided legal size document is not available.

Tray selection

You can change the Tray Use only for the next copy.

- 1 Load your document.
- 2 Use the dial pad to enter the number of copies (up to 99).
- 3 Press **Tray Select**.
- 4 Press ◀ or ▶ to choose the MP>T1, T1>MP, #1 (XXX)¹ or MP (XXX)¹. Press **OK**.
- 5 Press **Start**.

Press 	MP>T1 or M>T1>T2
	T1>MP or T1>T2>M
	#1 (XXX) ¹
	#2 (XXX) ¹
	MP (XXX) ¹

¹ XXX is the paper size you set in **Menu, 1, 1, 2**.



Note

- T2 or #2 appears only if the optional paper tray is installed.
- To change the default setting for Tray Select, see *Tray Use in copy mode* on page 23.

Out of memory message

If the memory becomes full while you are making copies, the LCD message will guide you through the next step.

If you get an **Out of Memory** message while scanning a subsequent page, you will have the option to press **Start** to copy the pages scanned so far, or to press **Stop/Exit** to cancel the operation.



Direct printing

**Printing data from a USB Flash memory drive
or a digital camera supporting mass storage 42**

6

Printing data from a USB Flash memory drive or a digital camera supporting mass storage

With the Direct Print feature, you do not need a computer to print data. You can print by just plugging your USB Flash memory drive into the machine's USB direct interface. You can also connect and print directly from a camera set to USB mass storage mode.

Note

- Some USB Flash memory drives may not work with the machine.
- If your camera is in PictBridge mode, you cannot print data. Please refer to the documentation supplied with your camera to switch from PictBridge mode to mass storage mode.

Supported file formats

Direct Print supports the following file formats:

- PDF version 1.7¹
- JPEG
- Exif + JPEG
- PRN (created by Brother driver)
- TIFF (scanned by all MFC or DCP Brother models)
- PostScript® 3™ (created by the Brother BRScrip3 printer driver)
- XPS version 1.0

¹ PDF data including a JBIG2 image file, a JPEG2000 image file, or transparency files are not supported.

Creating a PRN or PostScript® 3™ file for direct printing

Note

The screens in this section may vary depending on your application and operating system.

- 1 From the menu bar of an application, click **File**, then **Print**.
- 2 Choose **Brother DCPXXXX Printer** (1) and check the **Print to file** box (2). Click **Print**.

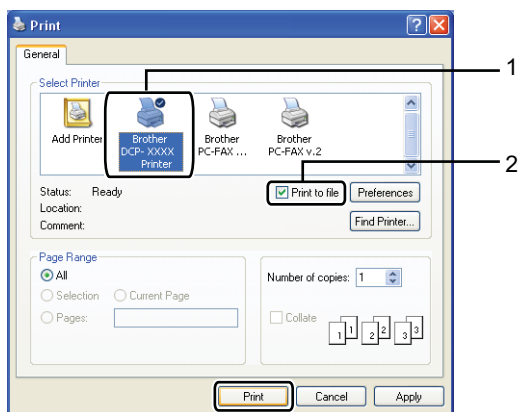

- 3 Choose the folder you want to save the file to and enter the file name if you are prompted to.

If you are prompted for a file name only, you can also specify the folder you want to save the file in by entering the directory name. For example:

C:\Temp\FileName.prn

If you have a USB Flash memory drive or digital camera connected to your computer, you can save the file directly to the USB Flash memory drive.

Printing data directly from the USB Flash memory drive or a digital camera supporting mass storage

- 1 Connect your USB Flash memory drive or digital camera to the USB direct interface (1) on the front of the machine. Your machine will enter Direct Print mode automatically.

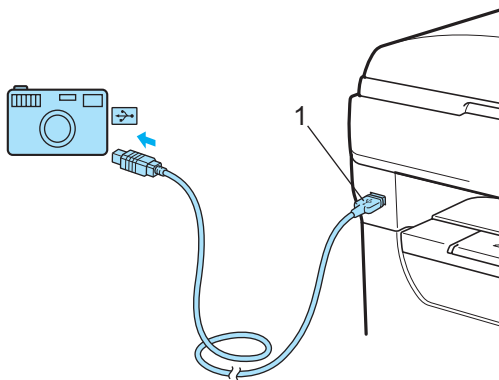

Note

- If the Direct Print setting of Secure Function Lock 2.0 is set to *Disable* for all users (including Public mode settings), *Not Available* will appear on the LCD and then the machine will go back to the Ready mode. You cannot access the Direct Print function.
- If the current restricted user ID you are using is restricted for the Direct Print function from Secure Function Lock 2.0, but other restricted users (including Public mode settings) are allowed access, *Access Denied* will appear on the LCD and then the machine will ask your name.

If you are a restricted user with access to Direct Print, press **▲** or **▼** to choose your name and enter your four-digit password.

- If your administrator has set a page limit for Direct Print and the machine has already reached the maximum number of pages, the LCD will show *Limit Exceeded* when you insert a USB flash memory drive or digital camera.

- 2 Press **▲** or **▼** to choose the folder name or file name you want to print.

```
Direct Print
▲1.FILE0_1.PDF
 2.FILE0_2.PDF
▼3.FILE0_3.PDF
Select ▲▼ or OK
```

Press **OK**.

If you have chosen the folder name, press **▲** or **▼** to choose the file name you want to print.

Press **OK**.

 **Note**

- Your digital camera must be switched from PictBridge mode to mass storage mode.
- If you want to print an index of the files, choose **Index Print**, and then press **OK**. Press **Start** to print the data.
- File names that are stored in your USB Flash memory drive can be displayed using the following characters on the LCD:
A B C D E F G H I J K L M N O P Q R S T
U V W X Y Z 0 1 2 3 4 5 6 7 8 9 \$ % ' ` - @
{ } ~ ! # () & _ ^

3 Do one of the following:

- Press **▲** or **▼** to choose a setting you need to change and press **OK**, and then press **▲** or **▼** to choose an option for the setting and press **OK**.
- If you do not need to change the current default settings, go to step **4**.

```
Print File Set
▲Paper Size
Media Type
▼Multiple Page
Select ▲▼ or OK
```

 **Note**

- You can choose the following settings:
 - Paper Size
 - Media Type
 - Multiple Page
 - Orientation
 - Duplex
 - Collate
 - Tray Use
 - Print Quality
 - PDF Option
- Depending on the file type, some of these settings may not appear.

4 Press **Start** if you have finished.

5 Press the dial pad key to enter the number of copies you want. Press **OK**.

```
Direct Print
FILE0_1.PDF
No. of Copies:
Press Start
```

6 Press **Start** to print the data.

 **IMPORTANT**

- To prevent damage to your machine, **DO NOT** connect any device other than a digital camera or USB Flash memory drive to the USB direct interface.
- **DO NOT** remove the USB Flash memory drive or digital camera from the USB direct interface until the machine has finished printing.

 **Note**

- If you want to change the default setting for the paper tray to feed paper from, press **Menu, 1, 4, 2** to change the paper tray setting.
- You can change the default settings for Direct Print by using the control panel when the machine is not in the Direct Print mode. Press **Menu, 4** to enter the USB Direct I/F menu. (See *Menu table* on page 106.)

Understanding the error messages

Once you are familiar with the types of errors that can occur while you print data from the USB Flash memory drive with Direct Print, you can easily identify and troubleshoot any problems.

■ Out of Memory

This message will appear if you are working with images that are too large for the machine's memory.

■ Unusable Device

This message will appear if you connect an incompatible or broken device to the USB direct interface. To clear the error, unplug the device from the USB direct interface.

(See *Error and maintenance messages* on page 75 for the detailed solution.)



Software

Software and Network features

48

7

Software and Network features

The HTML User's Guide on the CD-ROM includes **User's Guide**, **Software User's Guide** and **Network User's Guide** for features available when connected to a computer (for example, printing and scanning). These guides have easy to use links that, when clicked, will take you directly to a particular section.

You can find information on these features:

- Printing
- Scanning
- ControlCenter3 (Windows®)
- ControlCenter2 (Macintosh®)
- Network Printing
- Network Scanning



Note

See *Accessing the Software User's Guide and Network User's Guide* on page 3.

How to read the HTML User's Guide

This is a quick reference for using the HTML User's Guide.

Windows®



Note

If you have not installed the software, see *Viewing documentation (Windows®)* on page 3.

- 1 From the **Start** menu, point to **Brother**, **DCP-XXXX** from the programs group, then click **User's Guides in HTML format**.
- 2 Click on the manual you want (**USER'S GUIDE**, **SOFTWARE USER'S GUIDE** or **NETWORK USER'S GUIDE**) from the Top Menu.

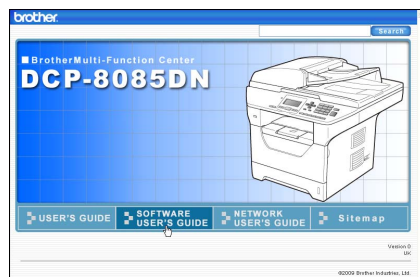

- 3 Click the heading you would like to view from the list at the left of the window.

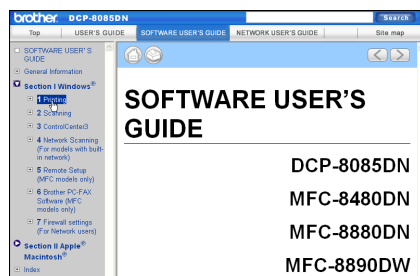

Macintosh®

- 1 Make sure your Macintosh® is turned on. Insert the Brother CD-ROM into your CD-ROM drive.
- 2 Double-click the **Documentation** icon.
- 3 Double-click your language folder, and then double-click the top.html file.
- 4 Click on the manual you want (**USER'S GUIDE**, **SOFTWARE USER'S GUIDE** or **NETWORK USER'S GUIDE**) in the top menu, and then click the heading you would like to read from the list at the left of the window.

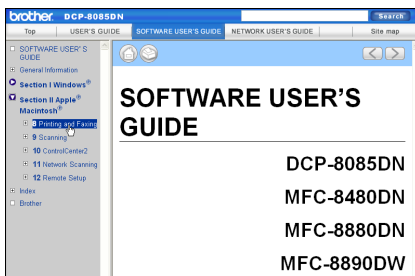



Appendixes

Safety and legal	52
Options	61
Troubleshooting and routine maintenance	63
Menu and features	104
Specifications	118
Glossary	132

A

Safety and legal

Choosing a location

Put your machine on a flat, stable surface that is free of vibration and shocks, such as a desk. Put the machine near a standard grounded electrical socket. Choose a location where the temperature remains between 10°C and 32.5°C and the humidity is between 20% to 80% (without condensation).

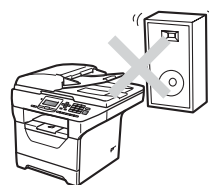
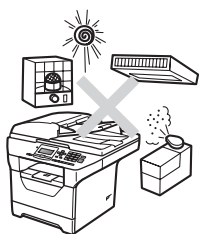

⚠ WARNING

DO NOT expose the machine to direct sunlight, excessive heat, open flames, salty or corrosive gasses, moisture or dust.

DO NOT place the machine near heaters, air conditioners, refrigerators, water or chemicals.

⚠ CAUTION

Avoid placing your machine in a high-traffic area.

Avoid placing your machine on a carpet.

DO NOT connect your machine to electrical socket controlled by wall switches or automatic timers, or to the same circuit as large appliances that might disrupt the power supply.

Disruption of power can wipe out information in the machine's memory.

Make sure cables leading to the machine do not constitute a trip hazard.

To use the machine safely

Please keep these instructions for later reference and read them before attempting any maintenance.

WARNING



There are high voltage electrodes inside the machine. Before you clean the inside of the machine, make sure you have unplugged the power cord from the electrical socket. Doing this will prevent an electrical shock.

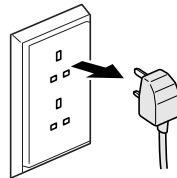

DO NOT handle the plug with wet hands. Doing this might cause an electrical shock. Always make sure the plug is fully inserted.

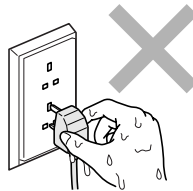

This product must be installed near an electrical socket that is easily accessible. In case of an emergency, you must unplug the power cord from the electrical socket to shut off the power completely.

Plastic bags are used in the packing of your machine and drum unit. To avoid the danger of suffocation, keep these bags away from babies and children.

DO NOT use flammable substances, any type of spray or any organic solvent/liquids contains alcohol or ammonia to clean the inside or outside of the machine. Doing this may cause a fire or electrical shock. See *Routine maintenance* on page 86 for how to clean the machine.



DO NOT use a vacuum cleaner to clean up scattered toner. Doing this might cause the toner dust to ignite inside the vacuum cleaner, potentially starting a fire. Please carefully clean the toner dust with a dry, lint-free soft cloth and dispose of it according to local regulations.

⚠ CAUTION



After you have just used the machine, some internal parts of the machine will be extremely hot. When you open the front or back cover of the machine, DO NOT touch the shaded parts shown in the illustration.

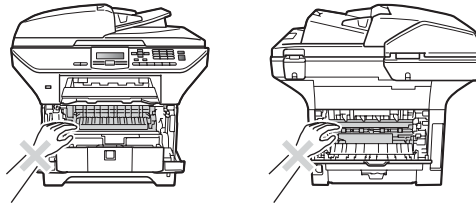

To prevent injuries, be careful not to put your hands on the edge of the machine under the document cover as shown in the illustration.

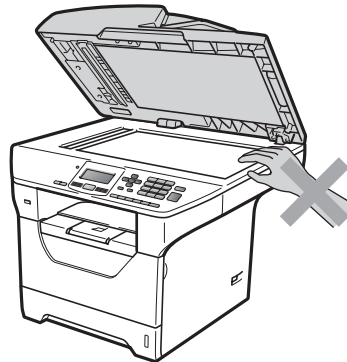

To prevent injuries, be careful not to put your fingers in the areas shown in the illustrations.

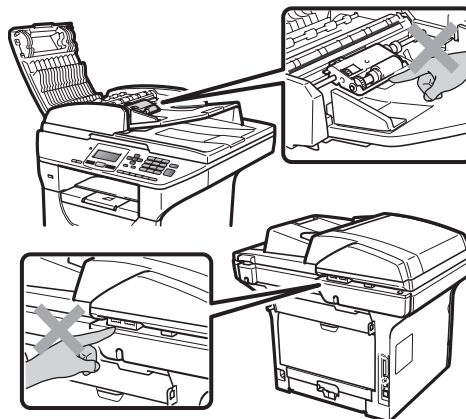

When you move the machine, grasp the side hand holds that are under the scanner.

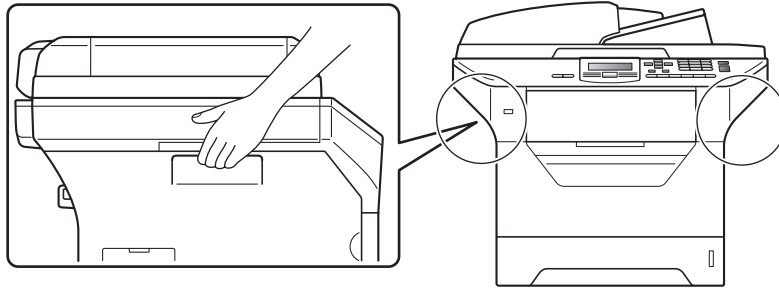

! IMPORTANT

The fuser unit is marked with a Caution label. Please **DO NOT** remove or damage the label.

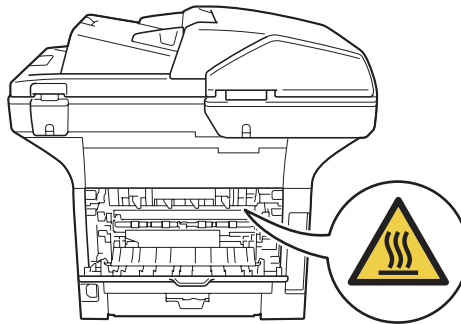

Important safety instructions

- 1 Read all of these instructions.
- 2 Save them for later reference.
- 3 Follow all warnings and instructions marked on the product.
- 4 Unplug this product from the wall socket before cleaning inside of the machine. **DO NOT** use liquid or aerosol cleaners. Use a dry, lint-free soft cloth for cleaning.
- 5 **DO NOT** place this product on an unstable cart, stand, or table. The product may fall, causing serious damage to the product.
- 6 Slots and openings in the casing at the back or bottom are provided for ventilation. To ensure reliable operation of the product and to protect it from overheating, these openings must not be blocked or covered. The openings should never be blocked by placing the product on a bed, sofa, rug, or other similar surface. This product should never be placed near or over a radiator or heater. This product should never be placed in a built-in installation unless adequate ventilation is provided.
- 7 This product should be connected to an AC power source within the range indicated on the rating label. **DO NOT** connect it to a DC power source or inverter. If you are not sure, contact a qualified electrician.
- 8 This product is equipped with a 3-wire grounded plug. This plug will only fit into a grounded power outlet. This is a safety feature. If you are unable to insert the plug into the outlet, call your electrician to replace your obsolete outlet. **DO NOT** defeat the purpose of the grounded plug.
- 9 Use only the power cord supplied with this machine.
- 10 **DO NOT** allow anything to rest on the power cord. **DO NOT** place this product where people can walk on the cord.
- 11 Use the product in a well-ventilated area.
- 12 The power cord, including extensions, should be no longer than 5 metres.

DO NOT share the same power circuit with other high powered appliances, such as an air conditioner, copier, shredder, and so on. If you cannot avoid using the printer with these appliances, we recommend that you use a voltage transformer or a high-frequency noise filter.

Use a voltage regulator if the power source is not stable.
- 13 **DO NOT** place anything in front of the machine that will block printed pages. **DO NOT** place anything in the path of printed pages.
- 14 Wait until pages have exited the machine before picking them up.

15 Unplug this product from the power socket and refer all servicing to Brother Authorized Service Personnel under the following conditions:

- When the power cord is damaged or frayed.
- If liquid has been spilled into the product.
- If the product has been exposed to rain or water.
- If the product does not operate normally when the operating instructions are followed. Adjust only those controls that are covered by the operating instructions. Incorrect adjustment of other controls may result in damage and will often require extensive work by a qualified technician to restore the product to normal operation.
- If the product has been dropped or the casing has been damaged.
- If the product exhibits a distinct change in performance, indicating a need for service.

16 To protect your product against power surges, we recommend the use of a power protection device (Surge Protector).

17 To reduce the risk of fire, electric shock and injury to people, note the following:

- DO NOT use this product near appliances that use water, a swimming pool or in a wet basement.
- DO NOT use the machine during an electrical storm. (There is the remote possibility of an electrical shock.)
- DO NOT use this product in the vicinity of a gas leak.

Libtiff Copyright and License

Use and Copyright

Copyright© 1988-1997 Sam Leffler

Copyright© 1991-1997 Silicon Graphics, Inc.

Permission to use, copy, modify, distribute, and sell this software and its documentation for any purpose is hereby granted without fee, provided that (i) the above copyright notices and this permission notice appear in all copies of the software and related documentation, and (ii) the names of Sam Leffler and Silicon Graphics may not be used in any advertising or publicity relating to the software without the specific, prior written permission of Sam Leffler and Silicon Graphics.

THE SOFTWARE IS PROVIDED "AS-IS" AND WITHOUT WARRANTY OF ANY KIND, EXPRESS, IMPLIED OR OTHERWISE, INCLUDING WITHOUT LIMITATION, ANY WARRANTY OF MERCHANTABILITY OR FITNESS FOR A PARTICULAR PURPOSE.

IN NO EVENT SHALL SAM LEFFLER OR SILICON GRAPHICS BE LIABLE FOR ANY SPECIAL, INCIDENTAL, INDIRECT OR CONSEQUENTIAL DAMAGES OF ANY KIND, OR ANY DAMAGES WHATSOEVER RESULTING FROM LOSS OF USE, DATA OR PROFITS, WHETHER OR NOT ADVISED OF THE POSSIBILITY OF DAMAGE, AND ON ANY THEORY OF LIABILITY, ARISING OUT OF OR IN CONNECTION WITH THE USE OR PERFORMANCE OF THIS SOFTWARE.

Trademarks

The Brother logo is a registered trademark of Brother Industries, Ltd.

Brother is a registered trademark of Brother Industries, Ltd.

Multi-Function Link is a registered trademark of Brother International Corporation.

Microsoft, Windows, Windows Server and Internet Explorer are registered trademarks of Microsoft Corporation in the United States and/or other countries.

Windows Vista is either a registered trademark or a trademark of Microsoft Corporation in the United States and other countries.

Apple, Macintosh, Safari and TrueType are trademarks of Apple Inc., registered in the United States and other countries.

Intel, and Pentium are trademarks of Intel Corporation in the U.S. and other countries.

AMD is a trademark of Advanced Micro Devices, Inc.

Adobe, Flash, Illustrator, PageMaker, Photoshop, PostScript and PostScript 3 are either registered trademarks or trademarks of Adobe Systems Incorporated in the United States and/or other countries.

Epson is a registered trademark and FX-80 and FX-850 are trademarks of Seiko Epson Corporation.

IBM and Proprinter are either registered trademarks or trademarks of International Business Machines Corporation in the United States and/or other countries.

Nuance, the Nuance logo, PaperPort and ScanSoft are trademarks or registered trademarks of Nuance Communications, Inc. or its affiliates in the United States and/or other countries.

Each company whose software title is mentioned in this manual has a Software License Agreement specific to its proprietary programs.

All other trademarks are the property of their respective owners.

Optional paper tray (LT-5300)

An optional lower tray can be installed, and it can hold up to 250 sheets of 80 g/m² paper.

When an optional tray is installed, the machine can hold up to 550 sheets of plain paper. If you want to buy an optional lower tray unit, contact your Brother dealer.

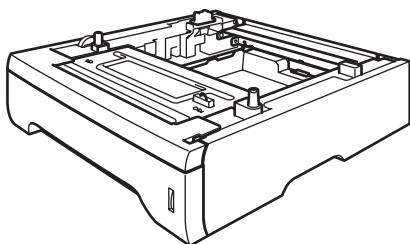

For setup, see the instructions that we have supplied with the lower tray unit.

Memory board

DCP-8085DN has 64 MB of standard memory and one slot for optional memory expansion. You can expand the memory up to 576 MB by installing small outline dual in-line memory modules (SO-DIMMs). When you add the optional memory, it increases the performance for both copier and printer operations.

In general, the SO-DIMMs with the following specifications:

Type: 144 pin and 64 bit output

CAS latency: 2

Clock frequency: 100 MHz or more

Capacity: 64, 128, 256 or 512 MB

Height: 31.75 mm

Dram Type: SDRAM 2 Bank

For purchasing information and part numbers visit the Buffalo Technology website:

<http://www.buffalo-technology.com/>



Note

- There might be some SO-DIMMs that will not work with the machine.
- For more information, contact your Brother dealer.

Installing extra memory

- 1 Turn off the machine's power switch.
- 2 Disconnect the interface cable from the machine, and then unplug the power cord from the electrical socket.



Note

Be sure to turn off the machine's power switch before you install or remove the SO-DIMM.

- 3 Remove the SO-DIMM cover and interface access cover.

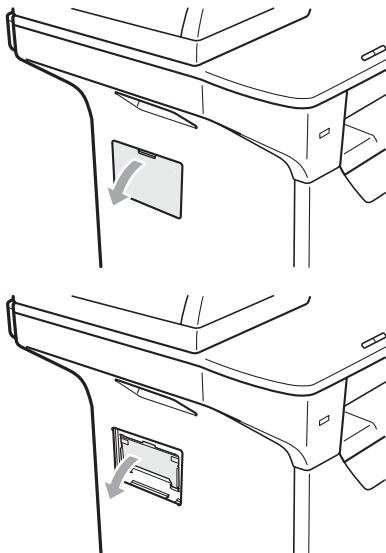

- 4 Unpack the SO-DIMM and hold it by its edges.

! IMPORTANT

To prevent damage to the machine from static electricity, DO NOT touch the memory chips or the board surface.

- 5 Hold the SO-DIMM by the edges and align the notches in the SO-DIMM with the protrusions in the slot. Insert the SO-DIMM diagonally (1), then tilt it toward the interface board until it clicks into place (2).

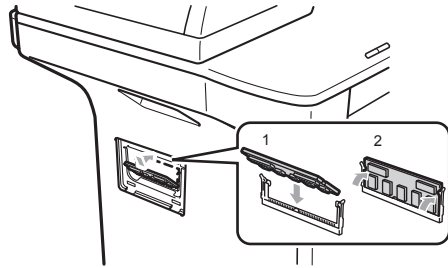

- 6 Put the interface access cover and the SO-DIMM cover back on.
- 7 Plug the machine's power cord back into the electrical socket first, and then connect the interface cable.
- 8 Turn on the machine's power switch.



Note

To make sure that you have installed the SO-DIMM properly, you can print the user settings page that shows the current memory size. (See *User Settings List* on page 26.)

Troubleshooting

If you think there is a problem with your machine, check the chart below and follow the troubleshooting tips.

Most problems can be easily resolved by yourself. If you need additional help, the Brother Solutions Center offers the latest FAQs and troubleshooting tips. Visit us at <http://solutions.brother.com>.

If you are having difficulty with your machine

Check the chart below and follow the troubleshooting tips.

Copy difficulties

Difficulties	Suggestions
Cannot make a copy.	Contact your administrator to check your Secure Function Lock Settings.
Vertical black line appears in copies.	Black vertical lines on copies are typically caused by dirt or correction fluid on the glass strip, or the corona wire for printing is dirty. (See <i>Cleaning the scanner</i> on page 87 and <i>Cleaning the corona wire</i> on page 90.)

Printing difficulties

Difficulties	Suggestions
No printout.	<ul style="list-style-type: none"> ■ Check that the machine is plugged in and the power switch is turned on. ■ Check that the toner cartridge and drum unit are installed correctly. (See <i>Replacing the drum unit</i> on page 98.) ■ Check the interface cable connection on both the machine and your computer. (See the <i>Quick Setup Guide</i>.) ■ Check that the correct printer driver has been installed and chosen. ■ Check to see if the LCD is showing an error message. (See <i>Error and maintenance messages</i> on page 75.) ■ Check the machine is online: (Windows® Vista®) Click the Start button, Control Panel, Hardware and Sound, and then Printers. Right-click Brother DCP-XXXX Printer. Make sure that Use Printer Offline is unchecked. (Windows® XP and Windows Server® 2003) Click the Start button and choose Printers. Right-click Brother DCP-XXXX Printer. Make sure that Use Printer Offline is unchecked. (Windows® 2000) Click the Start button and choose Settings and then Printers. Right-click Brother DCP-XXXX Printer. Make sure that Use Printer Offline is unchecked. ■ Contact your administrator to check your Secure Function Lock settings.
The machine prints unexpectedly or it prints garbage.	<ul style="list-style-type: none"> ■ Pull out the paper tray and wait until the machine stops printing. Then turn off the machine and disconnect from the power for several minutes. ■ Check the settings in your application to make sure it is set up to work with your machine. ■ If you are using the parallel port connection, check that the port is BRMFC and not LPT1.

Printing difficulties (continued)

Difficulties	Suggestions
The machine prints the first couple of pages correctly, then some pages have text missing.	<ul style="list-style-type: none"> ■ Check the settings in your application to make sure that it is set up to work with your machine. ■ Your computer is not recognising the machine's input buffer's full signal. Make sure that you connected the interface cable correctly. (See the <i>Quick Setup Guide</i>.)
The headers or footers appear when the document displays on the screen but they do not show up when it is printed.	There is an unprintable area on the top and bottom of the page. Adjust the top and bottom margins in your document to allow for this.
The machine does not print on both sides of the paper even though the printer driver setting is Duplex.	Check the paper size setting in the printer driver. You need to choose A4 size of paper.
The machine is not printing or has stopped printing and the machine's status LED is yellow.	Press Job Cancel . As the machine cancels the job and clears it from the memory it may produce an incomplete printout.

Scanning difficulties

Difficulties	Suggestions
TWAIN errors appear while scanning.	Make sure that the Brother TWAIN driver is chosen as the primary source. In PaperPort™ 11SE, click File, Scan or Get Photo and choose the Brother TWAIN driver .
OCR does not work.	Try increasing the scanning resolution.
Network scanning does not work.	See <i>Network difficulties</i> on page 65.

Software difficulties

Difficulties	Suggestions
Cannot install software or print.	Run the Repair MFL-Pro Suite program on the CD-ROM. This program will repair and reinstall the software.
Cannot perform '2 in 1' or '4 in 1' printing.	Check that the paper size setting in the application and in the printer driver are the same.
The machine does not print from Adobe® Illustrator®.	Try to reduce the print resolution. (See <i>Advanced tab</i> in the <i>Software User's Guide</i> on the CD-ROM.)

Paper handling difficulties

Difficulties	Suggestions
The machine does not load paper. The LCD shows No Paper or a Paper Jam message.	<ul style="list-style-type: none"> ■ If there is no paper, load a new stack of paper into the paper tray. ■ If there is paper in the paper tray, make sure it is straight. If the paper is curled, you should straighten it. Sometimes it is helpful to remove the paper, turn the stack over and put it back into the paper tray. ■ Reduce the amount of paper in the paper tray, and then try again. ■ Check that the MP tray mode is not chosen in the printer driver. ■ If the LCD shows Paper Jam message and you still have a problem, see <i>Paper jams</i> on page 80.
The machine does not feed paper from the MP tray.	<ul style="list-style-type: none"> ■ Fan the paper well and put it back in the tray firmly. ■ Make sure that MP tray mode is chosen in the printer driver.

Paper handling difficulties (continued)

Difficulties	Suggestions
How do I print on envelopes?	You can load envelopes from the MP tray. Your application must be set up to print the envelope size you are using. This is usually done in the Page Setup or Document Setup menu of your application. (See your application's manual for more information.)
What paper can I use?	You can use thin paper, plain paper, thick paper, bond paper, recycled paper, envelopes, labels and transparencies that are made for laser machines. (For details, see <i>Acceptable paper and other print media</i> on page 14.)
There is a paper jam.	(See <i>Paper jams</i> on page 80.)

Print quality difficulties

Difficulties	Suggestions
Printed pages are curled.	<ul style="list-style-type: none"> ■ Low quality thin or thick paper or not printing on the recommended side of the paper could cause this problem. Try turning over the stack of paper in the paper tray. ■ Make sure that you choose the Paper Type that suits the print media type you are using. (See <i>Acceptable paper and other print media</i> on page 14.)
Printed pages are smeared.	The Paper Type setting may be incorrect for the type of print media you are using, or the print media may be too thick or have a rough surface. (See <i>Acceptable paper and other print media</i> on page 14 and <i>Basic tab</i> in the <i>Software User's Guide</i> on the CD-ROM.)
Printouts are too light.	<ul style="list-style-type: none"> ■ If this problem occurs when making copies, set Toner Save mode to Off in the machine menu settings. (See <i>Toner Save</i> on page 24.) ■ Set Toner Save mode to Off in the Advanced tab in the printer driver. (See <i>Advanced tab</i> in the <i>Software User's Guide</i> on the CD-ROM.)

Network difficulties

Difficulties	Suggestions
Cannot print over a wired Network.	<p>If you are having Network problems see the <i>Network User's Guide</i> on the CD-ROM for more information.</p> <p>Make sure your machine is powered on and is on-line and in the Ready mode. Print the Network Configuration list to see your current Network settings. (See <i>Network Configuration List</i> on page 26.) Reconnect the LAN cable to the hub to verify that the cable and network connections are good. If possible, try connecting the machine to a different port on your hub using a different cable. If the connections are good, the lower LED of the back panel of the machine will be green.</p>

Network difficulties (continued)





Difficulties	Suggestions
<p>The network scanning feature does not work.</p> <p>The network printing feature does not work.</p>	<p>(Windows®) The firewall setting on your PC may be rejecting the necessary network connection. Follow the instructions below to configure Windows® Firewall. If you are using other personal firewall software, see the user's guide for your software or contact the software manufacturer.</p> <p>(Windows® XP SP2)</p> <ol style="list-style-type: none"> 1 Click the Start button, Control Panel, Network and Internet Connections and then Windows Firewall. Make sure that Windows Firewall on the General tab is set to On. 2 Click the Advanced tab and Settings... button of the Network Connection Settings. 3 Click the Add button. 4 To add port 54925 for network scanning, enter the information below: <ol style="list-style-type: none"> 1. In Description of service: Enter any description, for example "Brother Scanner". 2. In Name or IP address (for example 192.168.0.12) of the computer hosting this service on your network: Enter "Localhost". 3. In External Port number for this service: Enter "54925". 4. In Internal Port number for this service: Enter "54925". 5. Make sure UDP is chosen. 6. Click OK. 5 Click the Add button. 6 If you still have trouble with your network connection, click the Add button. 7 To add port 137 for network scanning and network printing, enter the information below: <ol style="list-style-type: none"> 1. In Description of service: - Enter any description, for example "Brother network scanning" 2. In Name or IP address (for example 192.168.0.12) of the computer hosting this service on your network: Enter "Localhost". 3. In External Port number for this service: Enter "137". 4. In Internal Port number for this service: Enter "137". 5. Make sure UDP is chosen. 6. Click OK. 8 Make sure if the new setting is added and is checked, and then click OK.

Network difficulties (continued)

Difficulties	Suggestions
<p>The network scanning feature does not work.</p> <p>The network printing feature does not work.</p> <p>(continued)</p>	<p>(Windows Vista®):</p> <ol style="list-style-type: none"> 1 Click the Start button, Control Panel, Network and Internet, Windows Firewall and click Change settings. 2 When the User Account Control screen appears, do the following. <ul style="list-style-type: none"> ■ Users who have administrator rights: Click Continue. ■ For users who do not have administrator rights: Enter the administrator password and click OK. 3 Make sure that Windows Firewall on the General tab is set to On. 4 Click the Exceptions tab. 5 Click the Add port... button. 6 To add port 54925 for network scanning, enter the information below: <ol style="list-style-type: none"> 1. In Name: Enter any description. (for example "Brother Scanner") 2. In Port number: Enter "54925". 3. Make sure UDP is chosen. Then click OK. 7 Click the Add port... button. 8 Make sure that the new setting is added and is checked, and then click Apply. 9 If you still have trouble with your network connection such as network scanning or printing, check File and Printer Sharing box in the Exceptions tab and then click Apply.
<p>Your computer cannot find your machine.</p>	<p>(Windows®) The firewall setting on your PC may be rejecting the necessary network connection. (For details, see the instructions above.)</p> <p>(Macintosh®) Re-select your machine in the Device Selector application located in Macintosh HD/Library/Printers/Brother/Utilities/DeviceSelector or from the Model pop-up menu of ControlCenter2.</p>



Improving the print quality

Examples of poor print quality	Recommendation
 <p>White lines across the page</p>	<ul style="list-style-type: none"> ■ Make sure that you use paper that meets our specifications. A rough surfaced paper or thick print media can cause the problem. (See <i>Acceptable paper and other print media</i> on page 14.) ■ Make sure that you choose the appropriate media type in the printer driver or in the machine's Paper Type menu setting. (See <i>Acceptable paper and other print media</i> on page 14 and <i>Basic tab</i> in the <i>Software User's Guide</i> on the CD-ROM.) ■ The problem may disappear by itself. Print multiple pages to clear this problem, especially if the machine has not been used for a long time. ■ The drum unit may be damaged. Put in a new drum unit. (See <i>Replacing the drum unit</i> on page 98.)
 <p>White lines down the page</p>	<ul style="list-style-type: none"> ■ Wipe the laser scanner windows with a dry, lint-free soft cloth. (See <i>Cleaning the laser scanner window</i> on page 88.) ■ Make sure that a torn sheet of paper is not inside the machine covering the scanner window. ■ The toner cartridge may be damaged. Put in a new toner cartridge. (See <i>Replacing a toner cartridge</i> on page 95.) ■ The drum unit may be damaged. Put in a new drum unit. (See <i>Replacing the drum unit</i> on page 98.)
 <p>Hollow print</p>	<ul style="list-style-type: none"> ■ Make sure that you use paper that meets our specifications. (See <i>Acceptable paper and other print media</i> on page 14.) ■ Choose Thick paper mode in the printer driver, choose Thick in the machine's Paper Type menu setting or use thinner paper than you are currently using. (See <i>Paper Type</i> on page 22 and <i>Basic tab</i> in the <i>Software User's Guide</i> on the CD-ROM.) ■ Check the machine's environment. Conditions such as high humidity can cause hollow print. (See <i>Choosing a location</i> on page 52.) ■ The drum unit may be damaged. Put in a new drum unit. (See <i>Replacing the drum unit</i> on page 98.)
 <p>Grey background</p>	<ul style="list-style-type: none"> ■ Make sure that you use paper that meets our specifications. (See <i>Acceptable paper and other print media</i> on page 14.) ■ Check the machine's environment. Conditions such as high temperatures and high humidity can increase the amount of background shading. (See <i>Choosing a location</i> on page 52.) ■ The toner cartridge may be damaged. Put in a new toner cartridge. (See <i>Replacing a toner cartridge</i> on page 95.) ■ The drum unit may be damaged. Put in a new drum unit. (See <i>Replacing the drum unit</i> on page 98.)

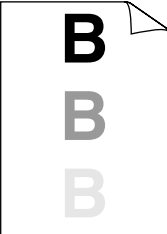
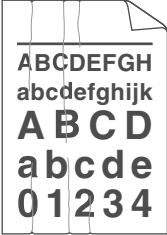
Examples of poor print quality	Recommendation
 <p data-bbox="234 552 385 581">Page skewed</p>	<ul style="list-style-type: none"> <li data-bbox="506 295 1251 382">■ Make sure that the paper or other print media is loaded correctly in the paper tray and that the guides are not too tight or too loose against the paper stack. <li data-bbox="506 394 1251 452">■ Set the paper guides correctly. (See <i>Loading paper in the standard paper tray</i> on page 10.) <li data-bbox="506 463 1251 521">■ If you are using the MP tray, see <i>Loading paper in the multi-purpose tray (MP tray)</i> on page 11. <li data-bbox="506 533 858 562">■ The paper tray may be too full. <li data-bbox="506 573 1251 631">■ Check the paper type and quality. (See <i>Acceptable paper and other print media</i> on page 14.)
 <p data-bbox="275 909 344 938">Ghost</p>	<ul style="list-style-type: none"> <li data-bbox="506 649 1251 736">■ Make sure that you use paper that meets our specifications. Rough-surfaced paper or thick paper may cause the problem. (See <i>Acceptable paper and other print media</i> on page 14.) <li data-bbox="506 747 1251 863">■ Make sure that you choose the correct media type in the printer driver or in the machine's Paper Type menu setting. (See <i>Acceptable paper and other print media</i> on page 14 and <i>Basic tab</i> in the <i>Software User's Guide</i> on the CD-ROM.) <li data-bbox="506 875 1188 933">■ The drum unit may be damaged. Put in a new drum unit. (See <i>Replacing the drum unit</i> on page 98.) <li data-bbox="506 944 1215 1002">■ The fuser unit may be contaminated. Call your Brother dealer for service.
 <p data-bbox="196 1277 423 1306">Wrinkles or creases</p>	<ul style="list-style-type: none"> <li data-bbox="506 1022 1251 1079">■ Check the paper type and quality. (See <i>Acceptable paper and other print media</i> on page 14.) <li data-bbox="506 1091 1251 1149">■ Make sure that paper is loaded correctly. (See <i>Loading paper in the standard paper tray</i> on page 10.) <li data-bbox="506 1161 1251 1219">■ Turn over the stack of paper in the tray or rotate the paper 180° in the input tray.

Examples of poor print quality

Recommendation



Envelope creases

- 1 Open the back cover.
- 2 Pull the blue lever until the mark (▶) reaches beside the mark (✉) as shown below.
- 3 Resend the print job.

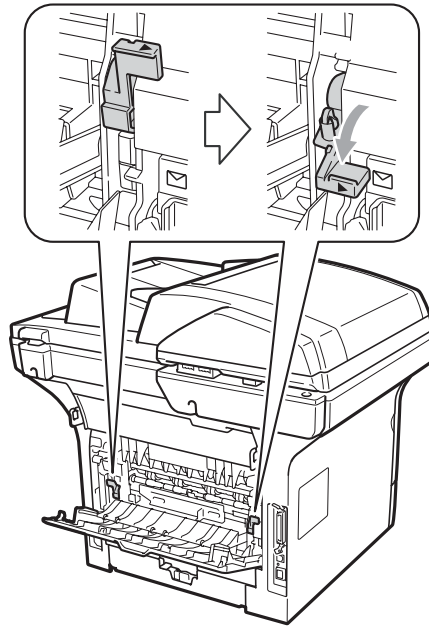

Note

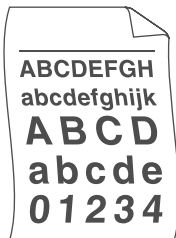

When you have finished printing, open the back cover and reset the two blue levers back to their original position.



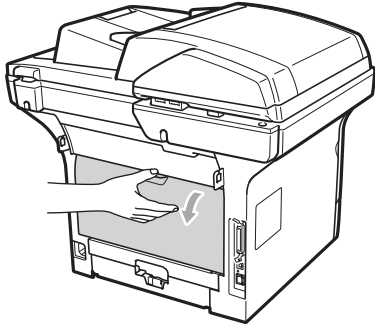
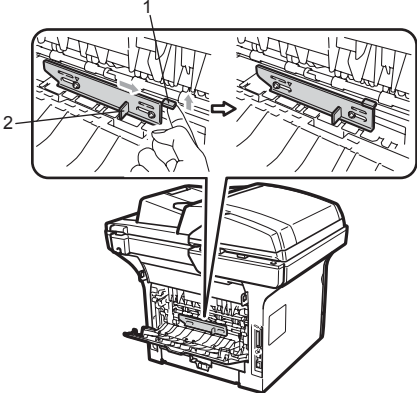
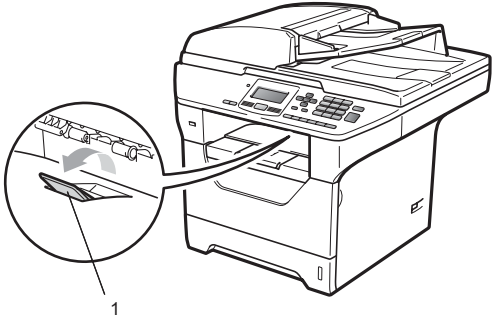

Curled or wavy

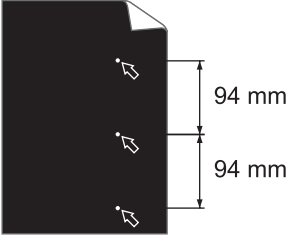
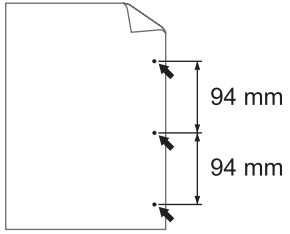
- Check the paper type and quality. High temperatures and high humidity will cause paper to curl.
- If you do not use the machine often, the paper may have been in the paper tray too long. Turn over the stack of paper in the paper tray. Also, fan the paper stack and then rotate the paper 180° in the paper tray.

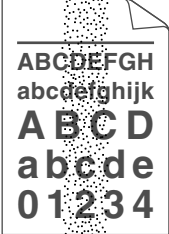
Examples of poor print quality	Recommendation
 <p data-bbox="271 566 348 591">Curled</p>	<ul style="list-style-type: none"> ■ Turn the paper over in the paper tray, and print again. (Excluding Letterhead paper) If the problem remains, switch the Anti-Curl Lever as follows: <ol style="list-style-type: none"> 1 Open the back cover.  <ol style="list-style-type: none"> 2 Lift the lever (1) and slide the lever (2) in the direction of the arrow.  <ul style="list-style-type: none"> ■ Lift up the Output Tray Support Flap (1).  <ul style="list-style-type: none"> ■ Choose Reduce Paper Curl mode in the printer driver. (See <i>Other Print Options</i> (for Windows®) or <i>Print Settings</i> (for Macintosh®) in the <i>Software User's Guide</i> on the CD-ROM.)

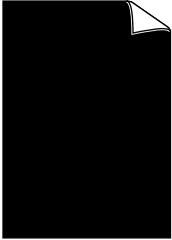
Examples of poor print quality	Recommendation
 <p>White Spots on black text and graphics at 94 mm intervals</p>  <p>Black Spots at 94 mm intervals</p>	<ul style="list-style-type: none"> ■ Make ten copies of a blank, white sheet of paper. (See <i>Making multiple copies</i> on page 32.) If the problem is not solved, the drum unit may have glue from a label stuck on the OPC drum surface. Clean the drum unit. (See <i>Cleaning the drum unit</i> on page 91.) ■ The drum unit may be damaged. Put in a new drum. (See <i>Replacing the drum unit</i> on page 98.)
 <p>Faint</p>	<ul style="list-style-type: none"> ■ Check the machine's environment. Conditions such as humidity, high temperatures, and so on, may cause this print fault. (See <i>Choosing a location</i> on page 52.) ■ If the whole page is too light, Toner Save mode may be on. Turn off Toner Save mode in the machine menu settings or Toner Save mode in the printer Properties of the driver. (See <i>Toner Save</i> on page 24 or <i>Advanced tab</i> in the <i>Software User's Guide</i> on the CD-ROM.) ■ Clean the scanner window and the corona wire of the drum unit. (See <i>Cleaning the laser scanner window</i> on page 88 and <i>Cleaning the corona wire</i> on page 90.) ■ The toner cartridge may be damaged. Put in a new toner cartridge. (See <i>Replacing a toner cartridge</i> on page 95.) ■ The drum unit may be damaged. Put in a new drum unit. (See <i>Replacing the drum unit</i> on page 98.)
 <p>Toner specks</p>	<ul style="list-style-type: none"> ■ Make sure that you use paper that meets our specifications. Rough-surfaced paper may cause the problem. (See <i>Acceptable paper and other print media</i> on page 14.) ■ Clean the corona wire and the drum unit. (See <i>Cleaning the corona wire</i> on page 90 and <i>Cleaning the drum unit</i> on page 91.) ■ The drum unit may be damaged. Put in a new drum unit. (See <i>Replacing the drum unit</i> on page 98.) ■ The fuser unit may be contaminated. Call your Brother dealer for service.

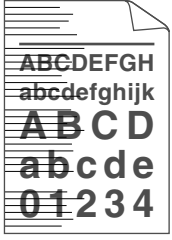
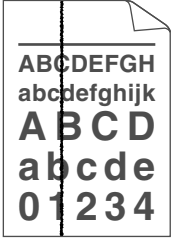
Examples of poor print quality	Recommendation
 <p data-bbox="257 556 362 581">All black</p>	<ul style="list-style-type: none"> <li data-bbox="504 295 1251 382">■ Clean the corona wire inside the drum unit by sliding the blue tab. Be sure to return the blue tab to the home position (▲). (See <i>Cleaning the corona wire</i> on page 90.) <li data-bbox="504 394 1188 452">■ The drum unit may be damaged. Put in a new drum unit. (See <i>Replacing the drum unit</i> on page 98.) <li data-bbox="504 463 1218 521">■ The fuser unit may be contaminated. Call your Brother dealer for service.
 <p data-bbox="142 857 471 915">Black toner marks across the page</p>	<ul style="list-style-type: none"> <li data-bbox="504 600 1226 658">■ Make sure that you use paper that meets our specifications. (See <i>Acceptable paper and other print media</i> on page 14.) <li data-bbox="504 670 1251 757">■ If you use label sheets for laser machines, the glue from the sheets may sometimes stick to the OPC drum surface. Clean the drum unit. (See <i>Cleaning the drum unit</i> on page 91.) <li data-bbox="504 768 1251 826">■ Do not use paper that has clips or staples because they will scratch the surface of the drum. <li data-bbox="504 838 1243 896">■ If the unpacked drum unit is in direct sunlight or room light, the unit may be damaged. <li data-bbox="504 908 1240 966">■ The toner cartridge may be damaged. Put in a new toner cartridge. (See <i>Replacing a toner cartridge</i> on page 95.) <li data-bbox="504 977 1188 1035">■ The drum unit may be damaged. Put in a new drum unit. (See <i>Replacing the drum unit</i> on page 98.)
 <p data-bbox="189 1315 430 1340">Line across the page</p>	<ul style="list-style-type: none"> <li data-bbox="504 1054 1251 1141">■ Clean the laser scanner window and the corona wire inside the drum unit. (See <i>Cleaning the laser scanner window</i> on page 88 and <i>Cleaning the corona wire</i> on page 90.) <li data-bbox="504 1153 1188 1211">■ The drum unit may be damaged. Put in a new drum unit. (See <i>Replacing the drum unit</i> on page 98.)
 <p data-bbox="156 1615 463 1711">Black lines down the page Printed pages have toner stains down the page</p>	<ul style="list-style-type: none"> <li data-bbox="504 1354 1251 1441">■ Clean the corona wire inside the drum unit by sliding the blue tab. Be sure to return the blue tab to the home position (▲). (See <i>Cleaning the corona wire</i> on page 90.) <li data-bbox="504 1452 1240 1510">■ The toner cartridge may be damaged. Put in a new toner cartridge. (See <i>Replacing a toner cartridge</i> on page 95.) <li data-bbox="504 1522 1188 1580">■ The drum unit may be damaged. Put in a new drum unit. (See <i>Replacing the drum unit</i> on page 98.) <li data-bbox="504 1591 1256 1630">■ The fuser unit may be smudged. Call your Brother dealer for service.

Examples of poor print quality

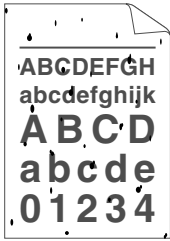

Poor fixing

Recommendation

- Open the back cover and make sure that the two blue levers on the left and right hand sides are in the up position.

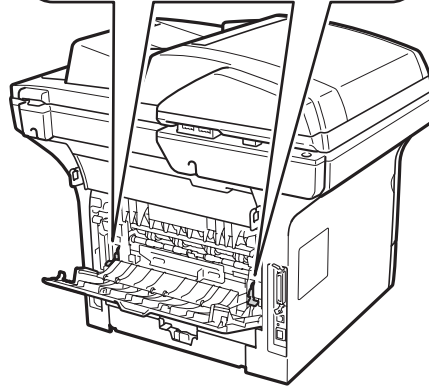
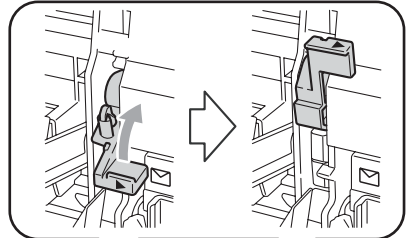

- Choose **Improve Toner Fixing** mode in the printer driver. (See *Other Print Options* (for Windows®) or *Print Settings* (for Macintosh®) in the *Software User's Guide* on the CD-ROM.)

If this selection does not provide enough improvement, choose **Thicker Paper** in **Media Type** settings.

Error and maintenance messages

As with any sophisticated office product, errors may occur and consumable items may need to be replaced. If this happens, your machine identifies the error or required routine maintenance and shows the appropriate message. The most common error and maintenance messages are shown below.

You can clear most errors and perform routine maintenance messages by yourself. If you need more help, the Brother Solutions Center offers the latest FAQs and troubleshooting tips.

Visit us at <http://solutions.brother.com/>.

Error Message	Cause	Action
Access Error	The device is removed from the USB direct interface while the data is processing.	Press Stop/Exit . Reinsert the device and try to print with Direct Print.
Cartridge Error	The toner cartridge is not installed correctly.	Pull out the drum unit, take out the toner cartridge that is indicated on the LCD, and put it back into the drum unit again.
Cooling Down Wait for a while	The temperature of the drum unit or toner cartridge is too hot. The machine will pause its current print job and go into cooling down mode. During the cooling down mode, you will hear the cooling fan running while the LCD shows Cooling Down, and Wait for a while.	<p>Make sure that you can hear the fan in the machine spinning and that the exhaust outlet is not blocked by something.</p> <p>If the fan is spinning, remove any obstacles that surround the exhaust outlet, and then leave the machine turned on but do not use it for several minutes.</p> <p>If the fan is not spinning, disconnect the machine from the power for several minutes, then reconnect it.</p>
Cover is Open	The front cover is not closed completely.	Close the front cover of the machine.
Cover is Open	The fuser cover is not closed completely or paper was jammed in the back of the machine when you turned on the power.	<ul style="list-style-type: none"> ■ Close the fuser cover of the machine. ■ Make sure paper is not jammed inside the back of the machine, and then close the fuser cover and press Start.
Document Jam	The document was not inserted or fed correctly, or the document scanned from the ADF was too long.	See <i>Document jams</i> on page 79 or <i>Using the automatic document feeder (ADF)</i> on page 20.
Drum Error	The corona wire on the drum unit needs to be cleaned.	Clean the corona wire on the drum unit. (See <i>Cleaning the corona wire</i> on page 90.)
	The drum unit has reached the end of its life.	Replace the drum unit. (See <i>Replacing the drum unit</i> on page 98.)
Duplex Disabled	The duplex tray is not installed properly.	Remove the duplex tray and install it again.

Error Message	Cause	Action
Fuser Error	The temperature of fuser unit does not rise at a specified temperature within specified time.	Turn the power switch off, wait a few seconds, and then turn it on again. Leave the machine for 15 minutes with the power on.
	The fuser unit is too hot.	
Jam Duplex	The paper is jammed in the duplex tray.	(See <i>Paper jams</i> on page 80.)
Jam Rear	The paper is jammed in the back of the machine.	(See <i>Paper jams</i> on page 80.)
Jam Inside	The paper is jammed inside the machine.	(See <i>Paper jams</i> on page 80.)
Jam MP Tray	The paper is jammed in the MP tray of the machine.	(See <i>Paper jams</i> on page 80.)
Jam Tray 1 Jam Tray 2	The paper is jammed in the paper tray of the machine.	(See <i>Paper jams</i> on page 80.)
No Paper	The machine is out of paper or paper is not correctly loaded in the paper tray.	Do one of the following: <ul style="list-style-type: none"> ■ Refill the paper in the paper tray or MP tray. ■ Remove the paper and load it again.
No Toner	The toner cartridge or the drum unit and toner cartridge assembly is not installed correctly.	Re-install the toner cartridge or the drum unit and toner cartridge assembly.
No Tray	The paper tray is not completely closed.	Close the paper tray properly.
Out of Memory	The machine's memory is full.	<p>Copy operation in progress</p> <p>Do one of the following:</p> <ul style="list-style-type: none"> ■ Press Start to copy the scanned pages. ■ Press Stop/Exit and wait until the other operations in progress finish, and then try again. ■ Clear the data from the memory. (See <i>Out of memory message</i> on page 39.) <p>Print operation in process</p> <p>Reduce print resolution. (See <i>Advanced tab</i> in the <i>Software User's Guide</i> on the CD-ROM.)</p>
Print Unable XX	The machine has a mechanical problem.	Disconnect the machine from the power for several minutes, then reconnect it.
Protected Device	The protect switch of the USB Flash memory drive is on.	Turn off the protect switch of the USB Flash memory drive.

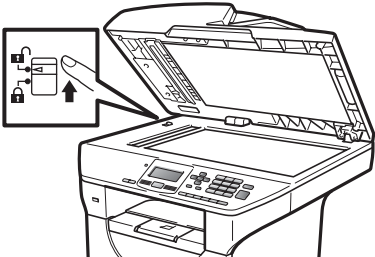
Error Message	Cause	Action
Replace Parts Drum	The drum unit is the end of its life.	Replace the drum unit. (See <i>Replacing the drum unit</i> on page 98.)
	The drum unit counter was not reset when a new drum was installed.	1 Open the front cover, and then press Clear/Back . 2 Press 1 to reset.
Replace Parts Fuser Unit	It is time to replace the fuser unit.	Call your Brother dealer to replace the fuser unit.
Replace Parts Laser Unit	It is time to replace the laser unit.	Call your Brother dealer to replace the laser unit.
Replace Parts PF kit MP	It is time to replace the paper feeding kit for the MP tray.	Call your Brother dealer to replace the PF Kit MP.
Replace Parts PF kit 1	It is time to replace the paper feeding kit for Tray 1.	Call your Brother dealer to replace the PF Kit 1.
Replace Parts PF kit 2	It is time to replace the paper feeding kit for Tray 2.	Call your Brother dealer to replace the PF Kit 2.
Rename the File	There is already a file on the USB Flash memory drive with the same name as the file you are trying to save.	Change the file name of the file on the USB Flash memory drive or the file you are trying to save.
Replace Toner	The toner cartridge is at the end of its life and printing is not possible.	Replace the toner cartridge with a new one. (See <i>Replacing a toner cartridge</i> on page 95.)
Scanner Locked	The scanner lock is locked.	Open the document cover, and then release the scanner lock lever.  Press Stop/Exit .
Scan Unable XX	The machine has a mechanical problem.	Disconnect the machine from the power for several minutes, then reconnect it.
	Document is too long for duplex scanning.	Press Stop/Exit . Use the appropriate size of paper for duplex scanning. (See <i>Scan</i> on page 123.)

Error Message	Cause	Action
Toner Low	If the LCD shows <code>Toner Low</code> , you can still print; however, the machine is telling you that the toner cartridge is near the end of its life and the toner will soon need replacing.	Order a new toner cartridge now.
Too Many Files	There are too many files stored on the USB Flash memory drive.	Reduce the number of files stored on the USB Flash memory drive.
Too Many Trays	More than one optional tray is installed.	The maximum number of optional trays is one. Remove any additional trays.
Unusable Device	An incompatible or broken device has been connected to the USB direct interface.	Remove the USB Flash memory drive from the USB direct interface.

Document jams

If the document is jammed, follow the steps below.

! IMPORTANT

After removing a jammed document, check that no paper scraps are left in the machine that could cause another jam.

Document is jammed in the top of the ADF unit

- 1 Take out any paper from the ADF that is not jammed.
- 2 Open the ADF cover.
- 3 Pull the jammed document out to the left.

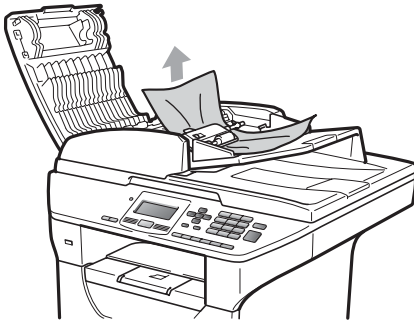

- 4 Close the ADF cover.
- 5 Press **Stop/Exit**.

Document is jammed under the document cover

- 1 Take out any paper from the ADF that is not jammed.
- 2 Lift the document cover.
- 3 Pull the jammed document out to the right.

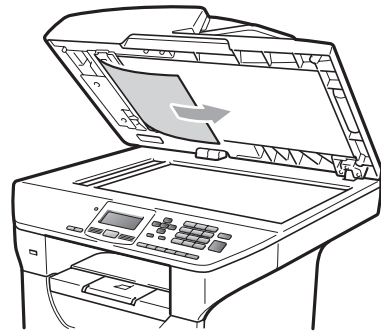

- 4 Close the document cover.
- 5 Press **Stop/Exit**.

Document is jammed at the output tray

- 1 Take out any paper from the ADF that is not jammed.
- 2 Pull the jammed document out to the right.

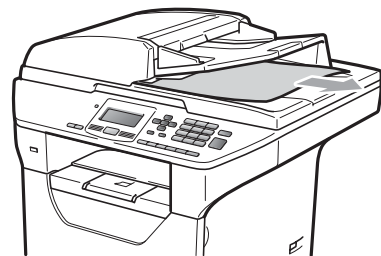

- 3 Press **Stop/Exit**.

Document is jammed in the duplex slot

- 1 Take out any paper from the ADF that is not jammed.
- 2 Pull the jammed document out to the right.



- 3 Press **Stop/Exit**.

Paper jams

To clear paper jams, please follow the steps in this section.

! IMPORTANT

Please confirm that you have installed both a toner cartridge and a drum unit in the machine. If you have not installed a drum unit or have installed the drum unit incorrectly, then this may cause a paper jam in your Brother machine.



Note

If the error message remains, open and close the front cover and fuser cover firmly to reset the machine.

! CAUTION



HOT SURFACE

After you have just used the machine, some internal parts of the machine will be extremely hot. To prevent injury, when you open the front or back cover (back output tray) of the machine DO NOT touch the shaded parts shown in the illustration.

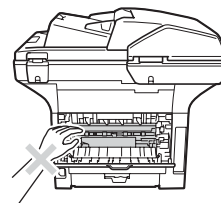
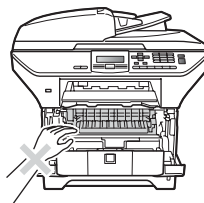

! IMPORTANT

To prevent damage to the machine caused by static electricity, **DO NOT** touch the electrodes shown in the illustration.

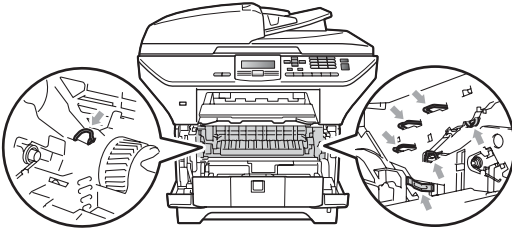

Note

The LCD names for the paper trays are as follows:

- Standard paper tray: Tray 1
- Optional lower tray: Tray 2
- Multi-purpose tray: MP Tray

Paper is jammed in the MP tray

If the LCD shows Jam MP Tray, follow these steps:

- 1 Remove the paper from the MP tray.
- 2 Remove any jammed paper from in and around the MP tray.

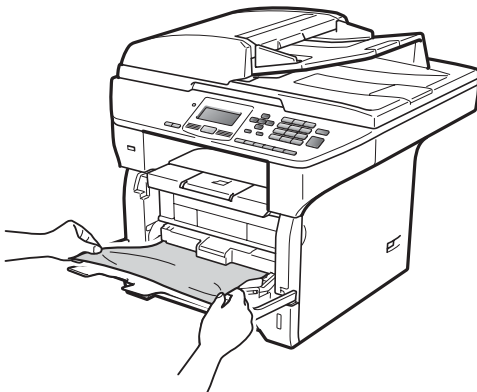

- 3 Close the MP tray. Then open the front cover and close it to reset the machine. Open the MP tray again.

- 4 Fan the paper stack, and then put it back in the MP tray.

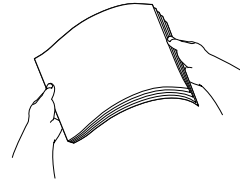

- 5 When loading paper in the MP tray, make sure that the paper stays under the maximum paper height guides on both sides of the tray.

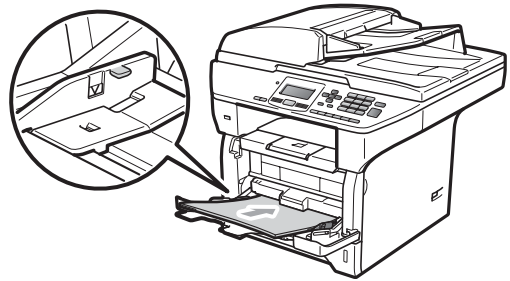

Paper is jammed in Paper Tray 1 or Tray 2

If the LCD shows Jam Tray 1 or Jam Tray 2, follow these steps:

- 1 Pull the paper tray completely out of the machine.
For Jam Tray 1:

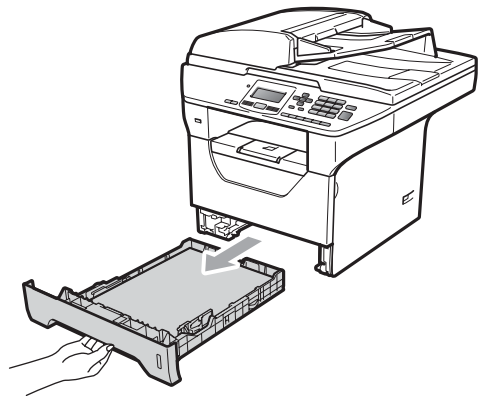

For Jam Tray 2:

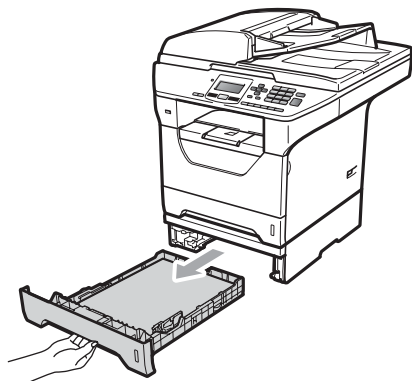

- 2 Use both hands to slowly pull out the jammed paper.



- 3 Make sure the paper is below the maximum paper mark (▼) of the paper tray. While pressing the blue paper-guide release lever, slide the paper guides to fit the paper size. Make sure that the guides are firmly in the slots.
- 4 Put the paper tray firmly back in the machine.

! IMPORTANT

DO NOT take out the standard paper tray while paper is feeding from a lower paper tray as this will cause a paper jam.

Paper is jammed inside the machine

- 1 Pull the paper tray completely out of the machine.
- 2 Use both hands to slowly pull out the jammed paper.

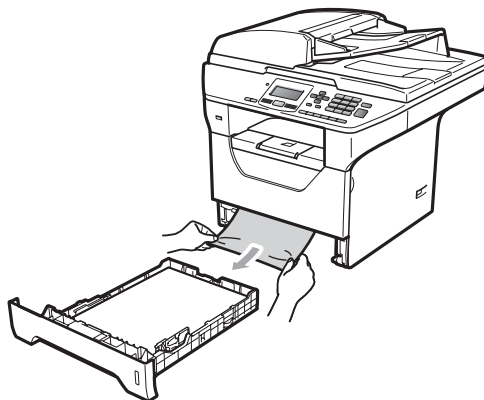

- 3 Press the front cover release button and open the front cover.

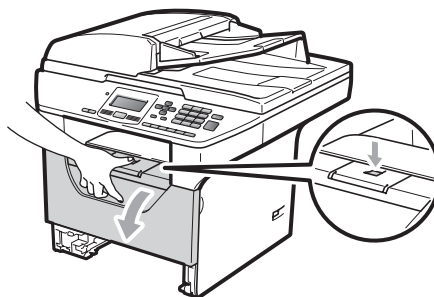

- 4 Slowly take out the drum unit and toner cartridge assembly. The jammed paper may be pulled out with the toner cartridge and drum unit assembly, or this may release the paper so you can pull it out of the paper tray opening.

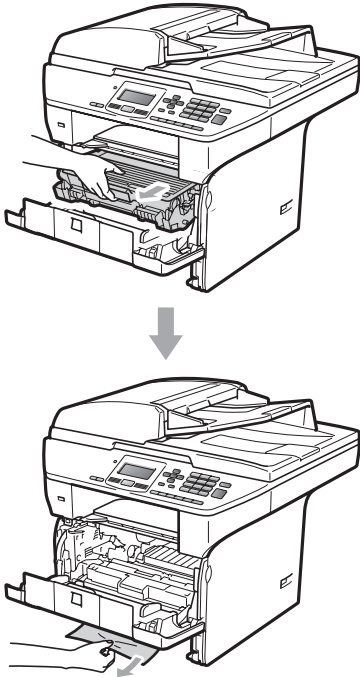

- 5 Put the drum unit and toner cartridge assembly back in the machine.

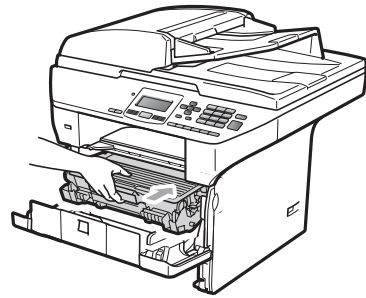

- 6 Close the front cover.

- 7 Put the paper tray firmly back in the machine.

Paper is jammed inside the drum unit and toner cartridge assembly

- 1 Press the front cover release button and open the front cover.

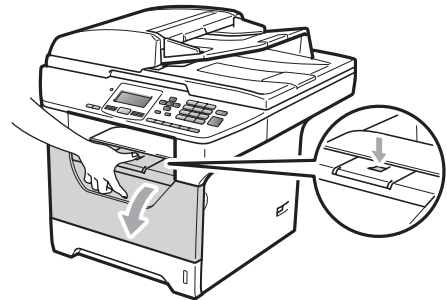

- 2 Slowly take out the drum unit and toner cartridge assembly.

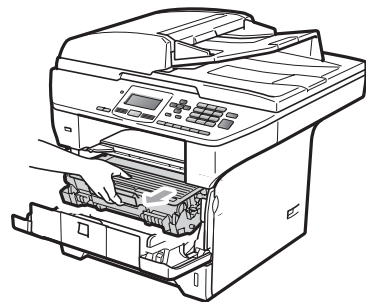

! IMPORTANT

We recommend that you place the drum unit and toner cartridge assembly on a clean, flat surface with a sheet of disposable paper or cloth underneath it in case you accidentally spill or scatter toner.

To prevent damage to the machine from static electricity, DO NOT touch the electrodes shown in the illustration.

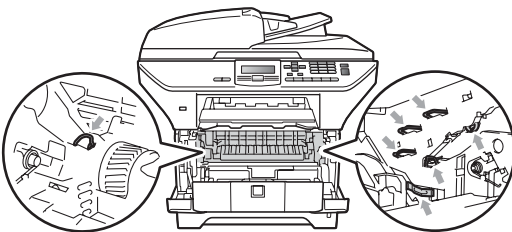

! IMPORTANT

We recommend that you place the drum unit and toner cartridge assembly on a clean, flat surface with a sheet of disposable paper or cloth underneath it in case you accidentally spill or scatter toner.

- 3 Push down the blue lock lever and take the toner cartridge out of the drum unit. Take out the jammed paper if there is any inside the drum unit.

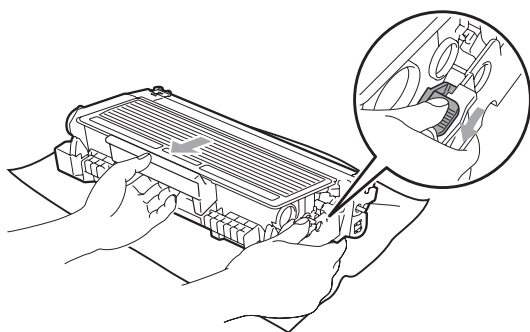

! IMPORTANT

- Handle the toner cartridge carefully. If toner scatters on your hands or clothes, wipe or wash it off with cold water at once.
- To avoid print quality problems, DO NOT touch the shaded parts shown in the illustrations below.

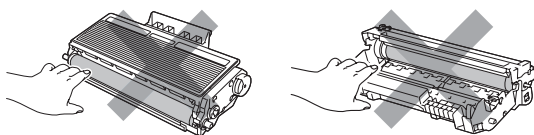

- 4 Clear the jammed paper if there is any inside the drum unit.

- 5 Put the toner cartridge back into the drum unit until you hear it lock into place. If you put it in correctly, the blue lock lever will lift automatically.

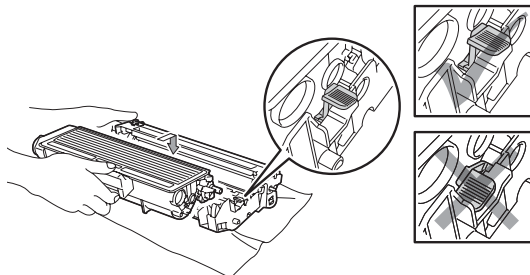

- 6 Put the drum unit and toner cartridge assembly back in the machine.

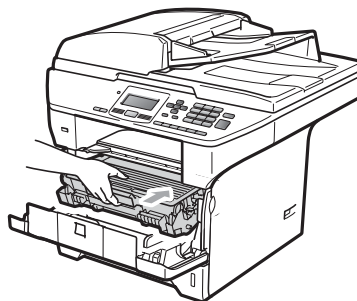

- 7 Close the front cover.

Paper is jammed at the back of the machine

- 1 Press the front cover release button and open the front cover.

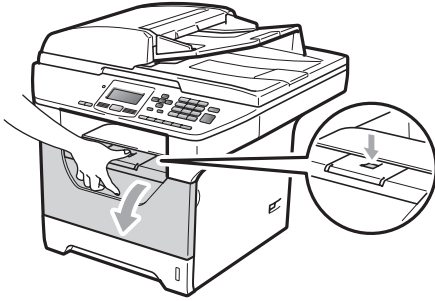

- 2 Slowly take out the drum unit and toner cartridge assembly.

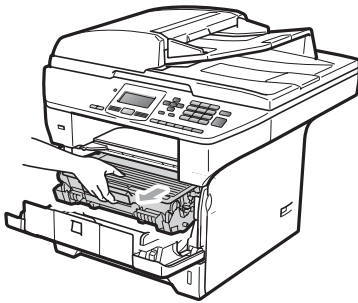

! IMPORTANT

We recommend that you place the drum unit and toner cartridge assembly on a clean, flat surface with a sheet of disposable paper or cloth underneath it in case you accidentally spill or scatter toner.

- 3 Open the back cover (back output tray).

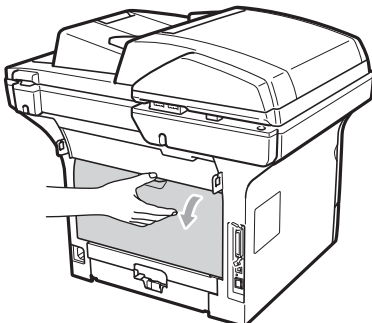

- 4 Pull the tabs at the left and right hand sides toward you to open the fuser cover (1).

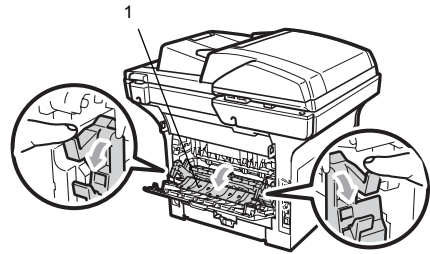

- 5 Pull the jammed paper out of the fuser unit.

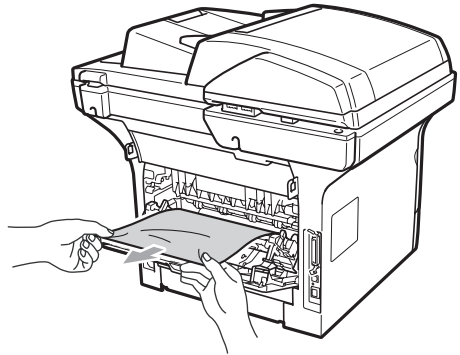

- 6 Close the fuser cover and back cover (back output tray).

- 7 Put the drum unit and toner cartridge assembly back in the machine.

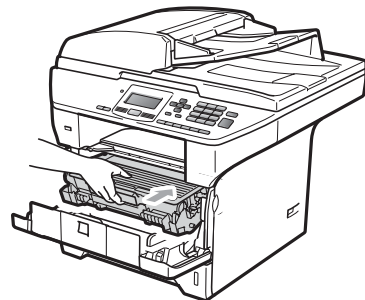

- 8 Close the front cover.

Paper is jammed in the duplex tray

- 1 Pull the duplex tray completely out of the machine.



- 2 Pull the jammed paper out of the machine or the duplex tray.

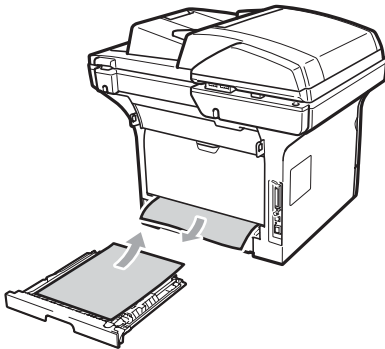

- 3 Put the duplex tray back in the machine.



Routine maintenance

⚠ WARNING

Use neutral detergents.

DO NOT use any flammable substances, spray or organic solvent/liquids containing alcohol/ammonia to clean the inside or outside of the machine. Doing this may cause a fire or electrical shock. (For more information, see *Important safety instructions* on page 57.)

⚠ IMPORTANT

The drum unit contains toner, so handle it carefully. If toner scatters on your hands or clothes, wipe or wash it off with cold water at once.

Cleaning the outside of the machine

- 1 Turn off the machine. Disconnect all cables, and then unplug the power cord from the electrical socket.
- 2 Pull the paper tray completely out of the machine.

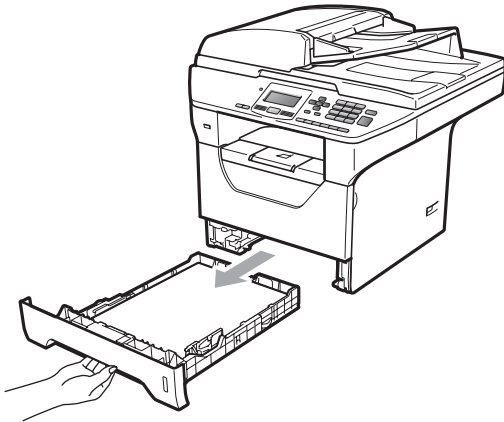

- 3 Wipe the outside of the machine with a dry, lint-free soft cloth to remove dust.

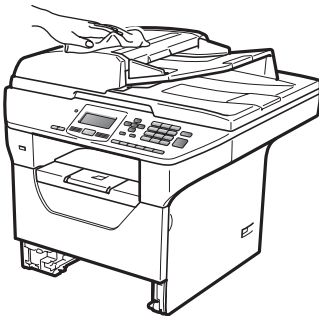

- 4 Remove any paper that is in the paper tray.

- 5 Wipe the inside and the outside of the paper tray with a dry, lint-free soft cloth to remove dust.

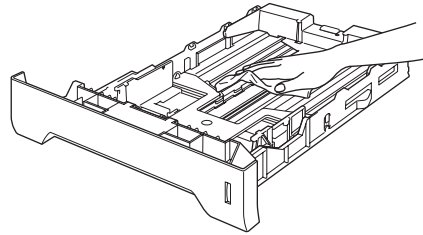

- 6 Re-load the paper and put the paper tray firmly back in the machine.
- 7 Plug the machine's power cord back into the electrical socket first, and reconnect all cables. Turn on the machine.

Cleaning the scanner

- 1 Turn off the machine. Disconnect all cables and then unplug the power cord from the electrical socket.
- 2 Lift the document cover (1). Clean the white plastic surface (2) and scanner glass (3) underneath it with a soft lint-free cloth moistened with water.

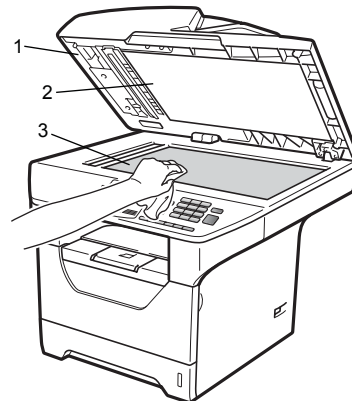

- 3 In the ADF unit, clean the white bar (1) and the scanner glass strip (2) underneath it with a soft lint-free cloth moistened with water.

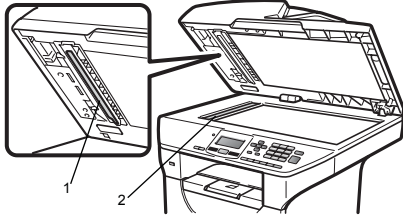

- 4 Plug the machine's power cord back into the electrical socket first, and reconnect all cables. Turn on the machine.



Note

In addition to cleaning the scanner glass and glass strip with a soft lint-free cloth moistened with water, run your finger tip over the glass to see if you can feel anything on it. If you feel dirt or debris, clean the glass again concentrating on that area. You may need to repeat the cleaning process three or four times. To test, make a copy after each cleaning.

Cleaning the laser scanner window

WARNING

Use neutral detergents.

DO NOT use any flammable substances, spray or organic solvent/liquids containing alcohol/ammonia to clean the inside or outside of the machine. Doing this may cause a fire or electrical shock. For more information see *Important safety instructions* on page 57.

IMPORTANT

DO NOT touch the laser scanner window with your fingers.

- 1 Before you clean the inside of the machine, turn off the machine. Unplug the power cord from the electrical socket.
- 2 Open the front cover and slowly take out the drum unit and toner cartridge assembly.

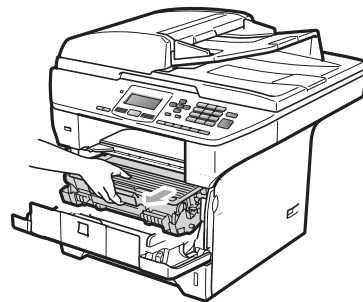

⚠ CAUTION

🔥 HOT SURFACE

After you have just used the machine, some internal parts of the machine will be extremely hot. To prevent injury, when you open the front or back cover (back output tray) of the machine DO NOT touch the shaded parts shown in the illustration.

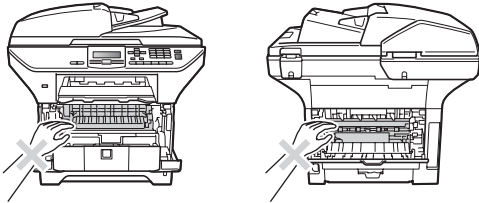

⚠ IMPORTANT

- To prevent damage to the machine caused by static electricity, DO NOT touch the electrodes shown in the illustration.

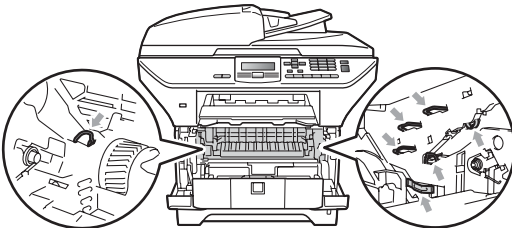

- We recommend that you place the drum unit on a clean, flat surface with a sheet of disposable paper or cloth underneath it in case you accidentally spill or scatter toner.

- 3 Wipe the laser scanner window (1) by wiping it with a dry, lint-free soft cloth.

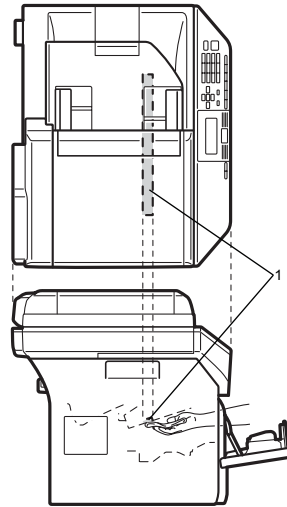

- 4 Put the drum unit and toner cartridge assembly back in the machine.

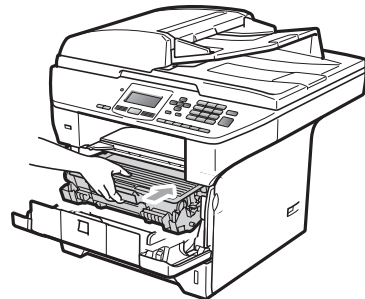

- 5 Close the front cover.
- 6 Plug the machine's power cord back into the electrical socket first. Turn on the machine.

Cleaning the corona wire

If you have print quality problems, clean the corona wire as follows:

- 1 Turn off the machine. Disconnect all cables, and then unplug the power cord from the electrical socket.
- 2 Open the front cover and slowly take out the drum unit and toner cartridge assembly.

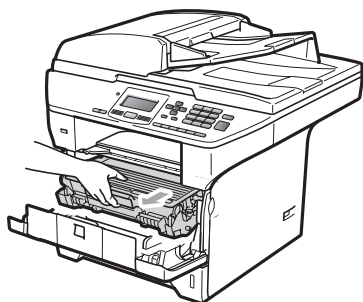

! IMPORTANT

- We recommend that you place the drum unit and toner cartridge assembly on a clean, flat surface with a sheet of disposable paper or cloth underneath it in case you accidentally spill or scatter toner.
- Handle the toner cartridge carefully. If toner scatters on your hands or clothes, wipe or wash it off with cold water at once.
- To prevent damage to the machine caused by static electricity, DO NOT touch the electrodes shown in the illustration.

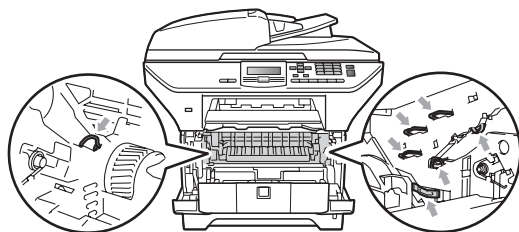

- 3 Clean the corona wire inside the drum unit by gently sliding the blue tab from right to left and left to right several times.

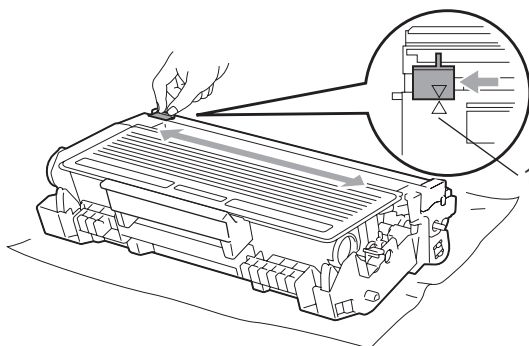

Note

Be sure to return the blue tab to the home position (▲) (1). If you do not, printed pages may have a vertical stripe.

- 4 Put the drum unit and toner cartridge assembly back in the machine.

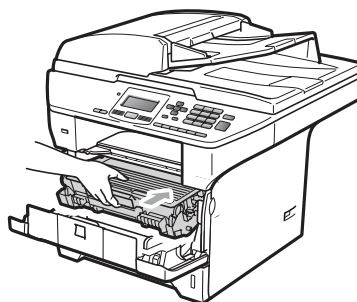

- 5 Close the front cover.

- 6 Plug the machine's power cord back into the electrical socket first, and then reconnect all cables. Turn on the machine.

! IMPORTANT

To avoid print quality problems, **DO NOT** touch the shaded parts shown in the illustrations below.

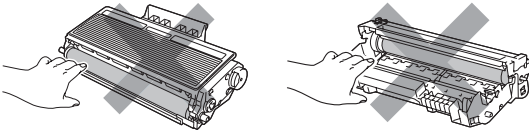

Cleaning the drum unit

If you have print quality problems, clean the drum unit as follows.

- 1 Turn off the machine. Unplug the power cord from the electrical socket.
- 2 Open the front cover and slowly take out the drum unit and toner cartridge assembly.

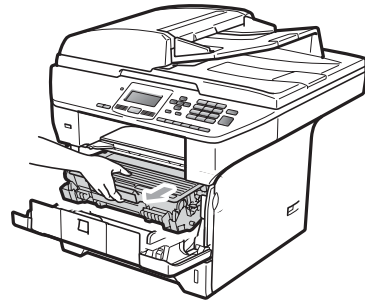

! IMPORTANT

- We recommend that you put the drum unit and toner cartridge assembly on a clean, flat surface with a sheet of disposable paper or cloth underneath it in case you accidentally spill or scatter toner.
- To prevent damage to the machine caused by static electricity, **DO NOT** touch the electrodes shown in the illustration.

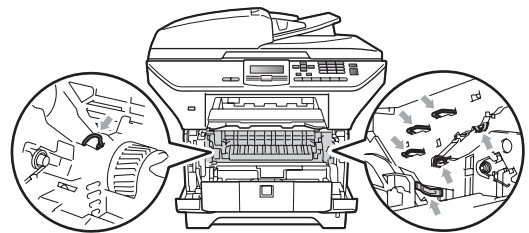

- 3 Push down the blue lock lever and take the toner cartridge out of the drum unit.

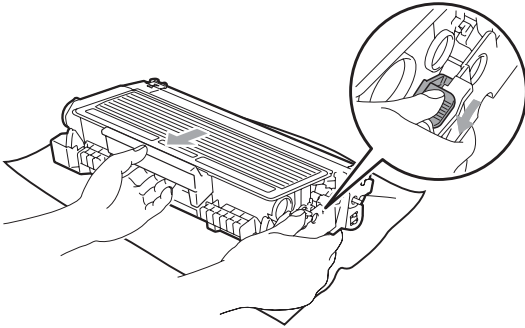

! IMPORTANT

- Handle the toner cartridge carefully. If toner scatters on your hands or clothes, wipe or wash it off with cold water at once.
- To avoid print quality problems, **DO NOT** touch the shaded parts shown in the illustrations below.

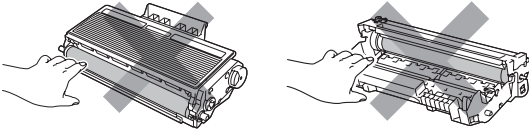

- 4 Put the print sample in front of the drum unit, and find the exact position of the poor print.

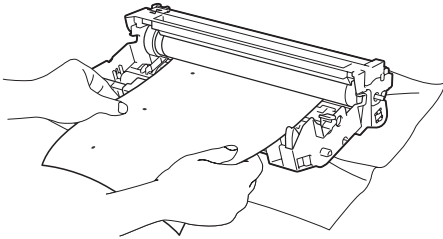

- 5 Turn the drum unit gear by hand while looking at the surface of the OPC drum (1).

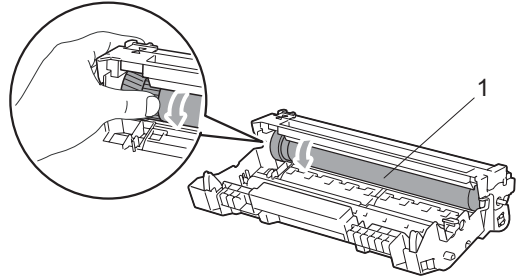

- 6 When you have found the mark on the drum that matches the print sample, wipe the surface of the OPC drum with a dry cotton swab until the dust or glue on the surface comes off.

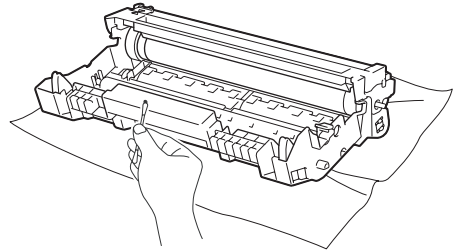

! IMPORTANT

- The drum is photosensitive so **DO NOT** touch it with your fingers.
- **DO NOT** clean the surface of the photosensitive drum with a sharp object.
- **DO NOT** use excessive force when cleaning the drum unit.

- 7 Put the toner cartridge back into the drum unit until you hear it lock into place. If you put the cartridge in correctly, the blue lock lever will lift automatically.

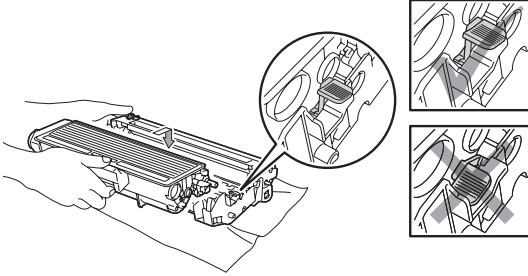

- 8 Put the drum unit and toner cartridge assembly back in the machine.

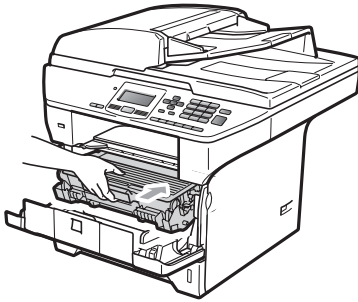

- 9 Close the front cover.
- 10 Plug the machine's power cord back into the electrical socket first, and then reconnect all cables. Turn on the machine.

Replacing the consumable items

You will need to replace the consumable items when the machine indicates that the life of the consumable is over.

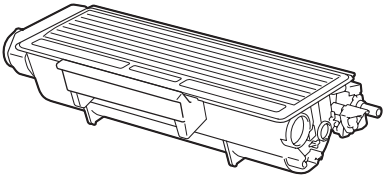
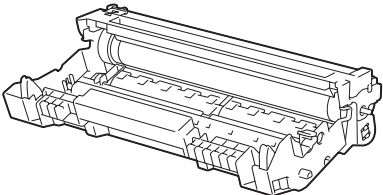
Toner cartridge	Drum unit
 A line drawing of a rectangular toner cartridge with a textured top surface and various connectors on the right side.	 A line drawing of a drum unit, which is a complex assembly with multiple rollers and a central drum.
Order No. TN-3230, TN-3280	Order No. DR-3200

! IMPORTANT

- We recommend placing used consumable items on a sheet of paper to prevent accidentally spilling or scattering the material inside.
- Be sure to reseal the consumable items tightly so that the material inside does not spill.

Note

- Discard used consumable items according to local regulations. (See *Quick Setup Guide*.) If you choose not to return your used consumable, please discard the used consumable according to local regulations, keeping it separate from domestic waste. If you have questions, call your local waste disposal office.
- If you use paper that is not a direct equivalent for the recommended paper, the life of consumable items and machine parts may be reduced.

Replacing a toner cartridge

The High Yield toner cartridges can print approximately 8,000 pages¹ and the Standard toner cartridges can print approximately 3,000 pages¹. Actual page count will vary depending on your average type of document (i.e., standard letter, detailed graphics). When a toner cartridge is running low, the LCD shows **Toner Low**.

¹ Approx. cartridge yield is declared in accordance with ISO/IEC 19752.



Note

It is a good idea to keep a new toner cartridge ready for use when you see the **Toner Low** warning.

⚠ CAUTION



HOT SURFACE

After you have just used the machine, some internal parts of the machine will be extremely hot. To prevent injury, when you open the front or back cover (back output tray) of the machine **DO NOT** touch the shaded parts shown in the illustration.

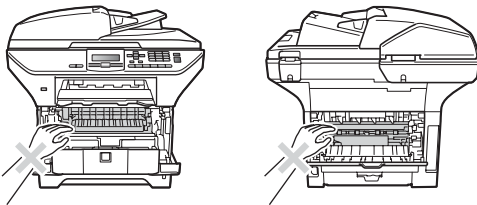

- 1 Press the front cover release button and open the front cover.

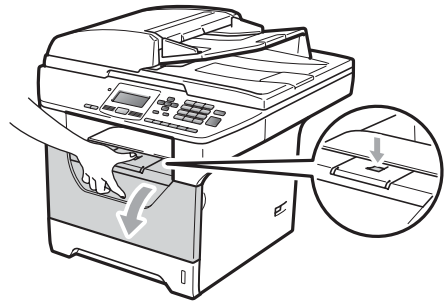

- 2 Slowly take out the drum unit and toner cartridge assembly.

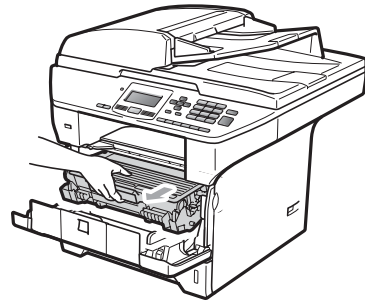

! IMPORTANT

- We recommend that you put the drum unit and toner cartridge assembly on a clean, flat surface with a sheet of disposable paper or cloth underneath it in case you accidentally spill or scatter toner.
- To prevent damage to the machine caused by static electricity, **DO NOT** touch the electrodes shown in the illustration.

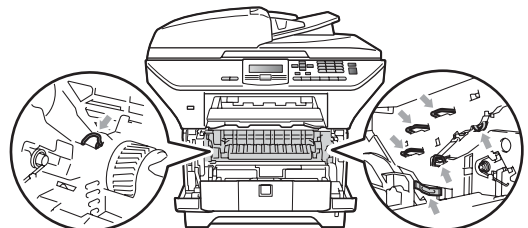

- 3 Push down the blue lock lever and take the used toner cartridge out of the drum unit.

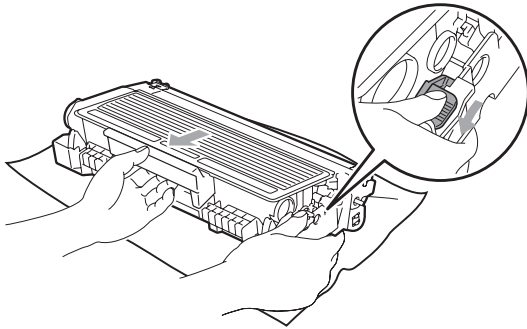

⚠ WARNING

DO NOT put a toner cartridge into a fire. It could explode, resulting in injuries.

! IMPORTANT

- Handle the toner cartridge carefully. If toner scatters on your hands or clothes, wipe or wash it off with cold water at once.
- To avoid print quality problems, DO NOT touch the shaded parts shown in the illustrations.

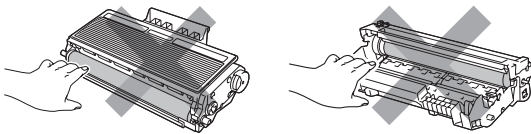

- Brother machines are designed to work with toner of a particular specification and will work to a level of optimum performance when used with genuine Brother toner cartridges (TN-3230/TN-3280). Brother cannot guarantee this optimum performance if toner or toner cartridges of other specifications are used. Brother does not therefore recommend the use of cartridges other

than genuine Brother cartridges with this machine, or the refilling of used cartridges with toner from other sources. If damage is caused to the drum unit or other part of this machine as a result of the use of toner or toner cartridges other than genuine Brother products due to the incompatibility or lack of suitability of those products with this machine, any repairs required as a result may not be covered by the warranty.

- Unpack the toner cartridges just before you put it in the machine. If a toner cartridge is left unpacked for a long time, the toner life will be shortened.
- Be sure to seal up the used toner cartridge tightly in a suitable bag so that toner powder does not spill out of the cartridge.

- 4 Unpack the new toner cartridge. Gently shake it from side to side several times to distribute the toner evenly inside the cartridge.

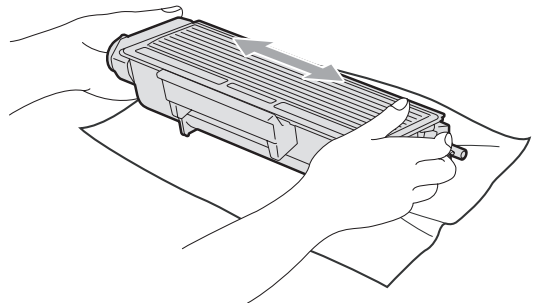

- 5 Pull off the protective cover.

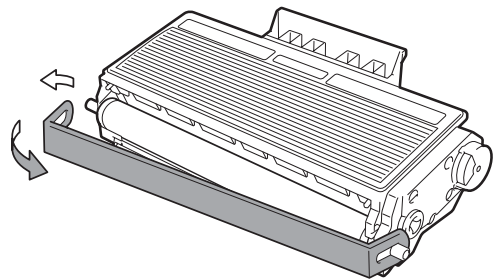

- 6 Put the new toner cartridge firmly into the drum unit until you hear it lock into place. If you put it in correctly, the lock lever will lift automatically.

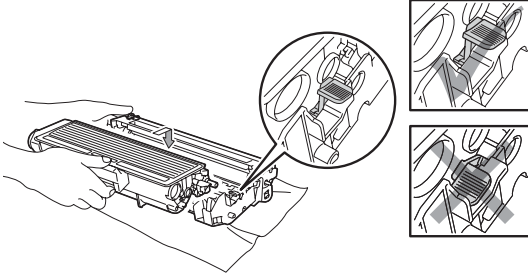

Note

Make sure that you put in the toner cartridge correctly or it may separate from the drum unit.

- 7 Clean the corona wire of the drum unit by gently sliding the blue tab from right to left and left to right several times.

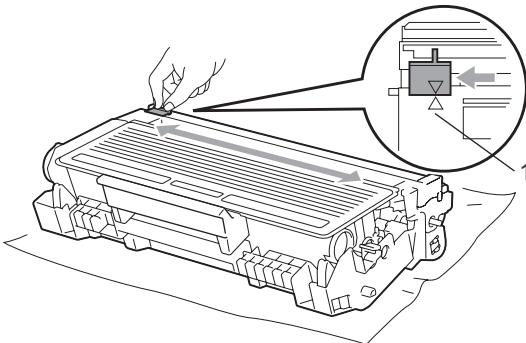

Note

Be sure to return the blue tab to the home position (▲) (1). If you do not, printed pages may have a vertical stripe.

- 8 Put the drum unit and toner cartridge assembly back in the machine.

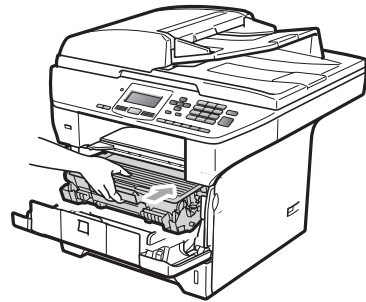

- 9 Close the front cover.



Note

DO NOT turn off the machine or open the front cover until the LCD returns to the standby state.

Replacing the drum unit

The machine uses a drum unit to create print images on paper. If the LCD shows *Replace Parts Drum*, the drum unit is near the end of its life and it is time to buy a new one. Even if the LCD shows *Replace Parts Drum*, you may be able to continue printing without having to replace the drum unit for a while. However, if there is a noticeable deterioration in the output print quality (even before *Replace Parts Drum* appears), then the drum unit should be replaced. You should clean the machine when you replace the drum unit. (See *Cleaning the laser scanner window* on page 88.)

! IMPORTANT

While removing the drum unit, handle it carefully because it may contain toner. If toner scatters on your hands or clothes, wipe or wash it off with cold water at once.

Note

The drum unit is a consumable item, and it is necessary to replace it periodically. There are many factors that determine the actual drum life, such as temperature, humidity, type of paper and how much toner you use for the number of pages per print job. The estimated drum life is approximately 25,000 pages¹. The actual number of pages your drum will print may be significantly less than this estimate. Because we have no control over the many factors that determine the actual drum life, we cannot guarantee a minimum number of pages that will be printed by your drum.

¹ Drum yield is approximate, and may vary by type of use.

! CAUTION

! HOT SURFACE

After you have just used the machine, some internal parts of the machine will be extremely hot. To prevent injury, when you open the front or back cover (back output tray) of the machine DO NOT touch the shaded parts shown in the illustration.

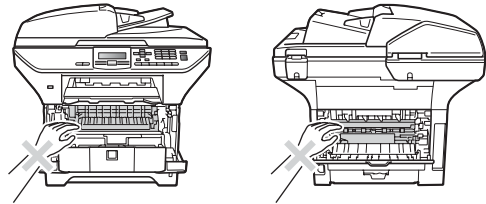

- 1 Press the front cover release button and open the front cover.

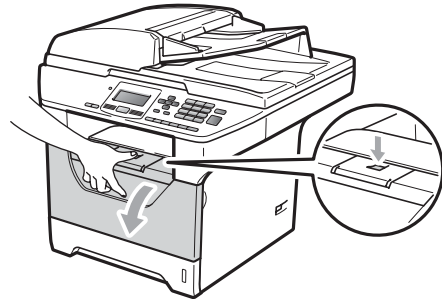

- 2 Slowly take out the drum unit and toner cartridge assembly.

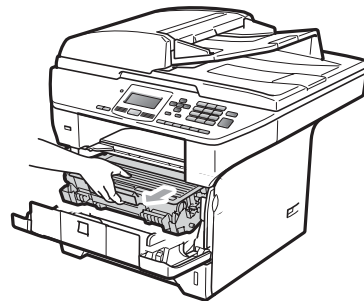

! IMPORTANT

- We recommend that you put the drum unit and toner cartridge assembly on a clean, flat surface with a sheet of disposable paper or cloth underneath it in case you accidentally spill or scatter toner.
- To prevent damage to the machine caused by static electricity, **DO NOT** touch the electrodes shown in the illustration.

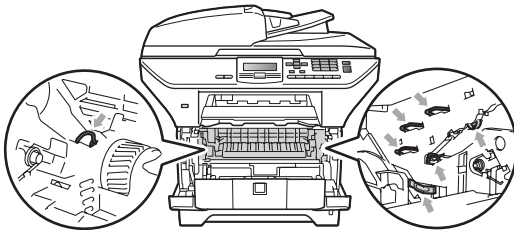

- 3 Push down the blue lock lever and take the toner cartridge out of the drum unit.

! IMPORTANT

- To avoid print quality problems, **DO NOT** touch the shaded parts shown in the illustrations.

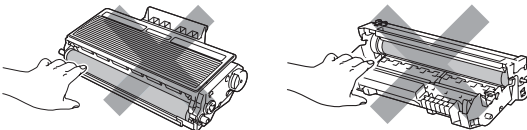

- Wait to unpack a new drum unit until immediately before you put it in the machine. Exposure to direct sunlight or room light may damage the drum unit.
- Be sure to seal up the used drum unit tightly in a bag so that toner powder does not spill out of the unit.

- 4 Unpack the new drum unit.

- 5 Put the toner cartridge firmly into the new drum unit until you hear it lock into place. If you put the cartridge in correctly, the blue lock lever will lift automatically.

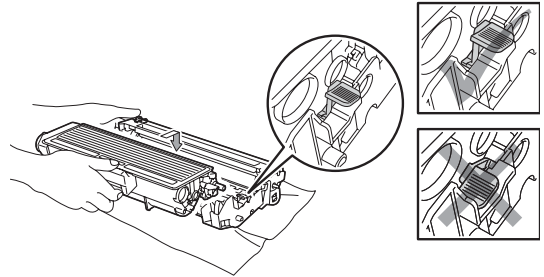

Note

Make sure that you put in the toner cartridge correctly or it may separate from the drum unit.

- 6 Put the new drum unit and toner cartridge assembly in the machine. Do not close the front cover.

- 7 Press **Clear/Back**.

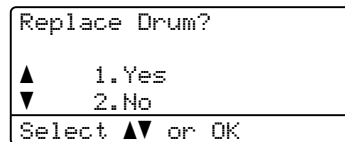

To confirm you are installing a new drum, press **1**.

- 8 When the LCD shows *Accepted*, close the front cover.

Replacing periodic maintenance parts

The periodic maintenance parts will need to be replaced regularly to maintain the print quality. The parts listed below will have to be replaced after printing approximately 50,000 pages for PF Kit MP and 100,000 pages for PF Kit1, PF Kit2, Fuser and Laser. Please call your Brother dealer when the following messages appear on the LCD.

LCD message	Description
Replace Parts PF kit MP	Replace paper feeding kit for MP tray.
Replace Parts PF kit 1	Replace paper feeding kit for Tray 1.
Replace Parts PF kit 2	Replace paper feeding kit for Tray 2.
Replace Parts Fuser Unit	Replace fuser unit.
Replace Parts Laser Unit	Replace laser unit.

Machine Information

Checking the Serial Number

You can see the machine's Serial Number on the LCD.

- 1 Press **Menu**, **6**, **3**.
- 2 Press **Stop/Exit**.

Checking the Page Counters

You can see the machine's Page Counters for copies, printed pages, reports and lists or a summary total.

- 1 Press **Menu**, **6**, **4**.
- 2 Press **▲** or **▼** to see **Total**, **List**, **Copy** or **Print**.
- 3 Press **Stop/Exit**.

Checking the remaining life of parts

You can see the remaining life of the machine's drum unit and periodic maintenance parts on the LCD.

- 1 Press **Menu**, **6**, **7**.
- 2 Press **▲** or **▼** to choose 1.Drum, 2.Fuser, 3.Laser, 4.PF kit MP, 5.PF kit 1 or 6..PF Kit 2¹. Press **OK**.
 - ¹ PF Kit 2 appears only when the optional LT-5300 tray is installed.
- 3 Press **Stop/Exit**.

Reset

The following reset functions are available:

- 1 Network

You can reset the print server back to its default factory settings such as the password and IP address information.
- 2 All Settings

You can reset all the machine settings back to the settings that were set at the factory.

Brother strongly recommends you use this operation when you dispose of the machine.



Note

Unplug the interface cable when you reset All Settings.

How to reset

- 1 Press **Menu**, **1**, **8**.
- 2 Press **▲** or **▼** to choose 1.Network or 2.All Settings. Press **OK**.
- 3 Press **▲** or **▼** to choose 1.Reset or 2.Exit. Press **OK**.
- 4 If you chose 1.Reset in step 3, you will be asked to reboot the machine. Press **▲** or **▼** to choose 1.Yes or 2.No. Press **OK**.

If you choose 1.Yes, the machine will begin the Restart.



Note

You can also reset the Network settings by pressing **Menu**, **5**, **0**.

Packing and shipping the machine

⚠ CAUTION

Make sure that the machine has fully cooled down by leaving it disconnected from the power for at least 30 minutes before packing.

When you transport the machine, use the packing materials that came with your machine. If you do not pack the machine correctly, you could void your warranty.

- 1 Turn off the machine.
- 2 Unplug all the cables and AC power cord from the machine.
- 3 Push the Scanner Lock Lever down to lock the scanner. This lever is located on the left of the scanner glass.

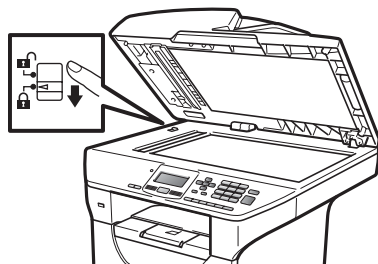

! IMPORTANT

Damage caused to your machine by failure to lock the scanner before packing and shipping may void your warranty.

- 4 Press the front cover release button and open the front cover.
- 5 Take out the drum unit and toner cartridge assembly. Leave the toner cartridge installed in the drum unit.

- 6 Put the drum unit and toner cartridge assembly into a plastic bag and seal the bag.
- 7 Close the front cover.
- 8 Put the styrofoam piece marked "FRONT" into the original carton (1). Pack the drum unit and toner cartridge assembly (2) and put it in as shown below (3). Wrap the machine in the plastic bag and put it in the original carton (4). Put the printed material behind the machine (5).

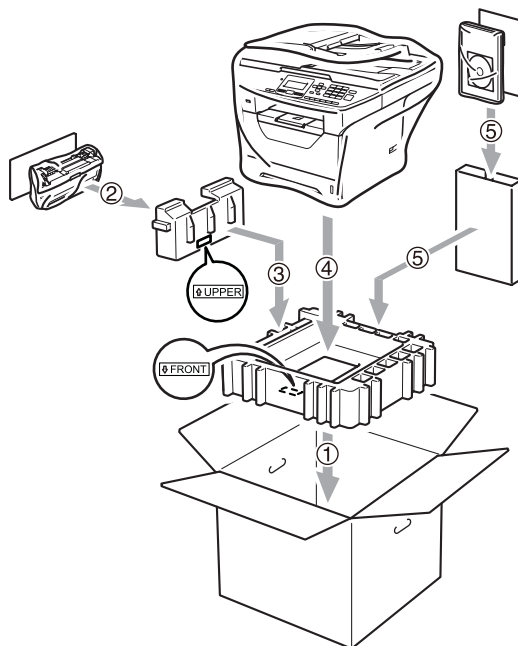

- 9 Take the two styrofoam pieces and match the front of the machine to the “FRONT” mark on the one of the styrofoam pieces, and the back of the machine to the “REAR” mark on the other styrofoam piece (6). Put the AC power cord and printed materials in the original carton as shown below (7).

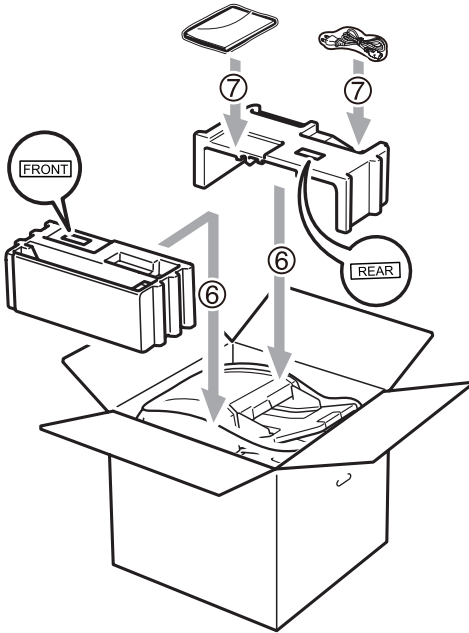

- 10 Close the carton and tape it shut.

D

Menu and features

On-screen programming

Your machine has been designed to be easy to use. The LCD provides on-screen programming using the menu keys.

We have created step by step on-screen instructions to help you program your machine. Simply follow the steps as they guide you through the menu selections and programming options.

Menu table

You can program your machine by using the *Menu table* on page 106. These pages list the menu selections and options.

Press **Menu** followed by the menu numbers to program your machine.

For example, to set *Beeper* volume to *Low*:

- 1 Press **Menu**, **1**, **2**.
- 2 Press **▲** or **▼** to choose *Low*.
- 3 Press **OK**.

Memory storage

Your menu settings are stored permanently, and in the event of a power failure will *not* be lost. Temporary settings (for example, *Contrast*) *will* be lost.

Menu keys

	Access the menu.
	Go to the next menu level. Accept an option.
	Exit the menu by pressing repeatedly. Go back to the previous menu level.
 	Scroll through the current menu level.
	Go back to the previous menu level or forward to the next menu level.
	Exit the menu.

How to access the menu mode

- 1 Press **Menu**.
- 2 Choose an option.
 - Press **1** for General Setup menu.
 - Press **2** for Copy menu.
 - Press **3** for Printer menu.
 - Press **4** for USB Direct I/F menu.
 - Press **5** for Network menu.
 - Press **6** for Machine Info. menu.

You can also scroll through each menu level by pressing ▲ or ▼ for the direction you want.

- 3 Press **OK** when the option you want appears on the LCD.
The LCD will then show the next menu level.
- 4 Press ▲ or ▼ to scroll to your next menu selection.
- 5 Press **OK**.
When you have finished setting an option, the LCD will show *Accepted*.
- 6 Press **Stop/Exit** to exit Menu mode.

Menu table

The factory settings are shown in Bold with an asterisk.

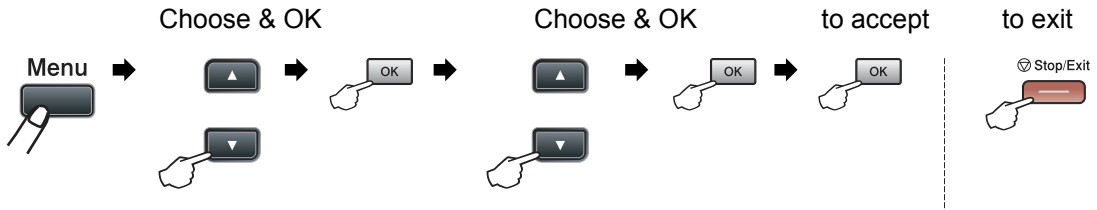

Main Menu	Submenu	Menu Selections		Options	Descriptions	Page
1.General Setup	1.Paper	1.Paper Type	1.MP Tray	Thin Plain* Thick Thicker Transparency Recycled Paper	Sets the type of paper in the MP tray.	22
			2.Tray#1	Thin Plain* Thick Thicker Transparency Recycled Paper	Sets the type of paper in the paper tray.	22
			3.Tray#2 (This menu only appears if you have the optional tray #2.)	Thin Plain* Thick Thicker Recycled Paper	Sets the type of paper in the optional paper tray #2.	22

Main Menu	Submenu	Menu Selections		Options	Descriptions	Page		
1.General Setup (Continued)	1.Paper (Continued)	2.Paper Size	1.MP Tray	A4* Letter Legal Executive A5 A5 L A6 B5 B6 Folio Any	Sets the size of the paper in the MP tray.	22		
			2.Tray#1	A4* Letter Executive A5 A5 L A6 B5 B6			Sets the size of the paper in the paper tray.	22
			3.Tray#2 (This menu only appears if you have the optional tray #2.)	A4* Letter Executive A5 B5 B6				

Main Menu	Submenu	Menu Selections	Options	Descriptions	Page
1.General Setup (Continued)	2.Beeper	—	Off Low Med* High	Adjusts the volume level of the beeper.	24
	3.Ecology	1.Toner Save	On Off*	Increases the page yield of the toner cartridge.	24
		2.Sleep Time	Range varies depending on model. 005Min*	Conserves power.	25
	4.Tray Use	1.Copy	Tray#1 Only Tray#2 Only MP Only MP>T1>T2* T1>T2>MP (Tray#2 or T2 appears only if you installed the optional paper tray.)	Selects the tray that will be used for Copy mode.	23
		2.Print	Tray#1 Only Tray#2 Only MP Only MP>T1>T2* T1>T2>MP (Tray#2 or T2 appears only if you installed the optional paper tray.)	Selects the tray that will be used for PC print.	23
	5.LCD Contrast	—	-□□□■+ -□□□■+ -□□■□+* -□■□□+ -■□□□+	Adjusts the contrast of the LCD.	25
	6.Function Lock	—	—	Can restrict selected machine operation for up to 25 individual users and all other non-authorized Public users.	27

Main Menu	Submenu	Menu Selections	Options	Descriptions	Page	
1.General Setup (Continued)	7.Document Scan	1.Glass ScanSize	A4* Letter Legal/Folio	Adjusts the scan area of the scanner glass to the size of the document.	See the <i>Software User's Guide</i> on the CD-ROM	
		2.File size	1.Color	Small Middle* Large		You can set your own default settings of the data compression rate.
			2.Gray	Small Middle* Large		
		3.Duplex Scan	Long edge* Short edge	Chooses the duplex scanning format.		
	8.Reset	1.Network	1.Reset 2.Exit	Resets all network and machine settings to the factory default settings.	101	
		2.All Settings	1.Reset 2.Exit			
	0.Local Language	—	(Choose your language.)	Allows you to change the LCD language for your country.	See <i>Quick Setup Guide</i> .	

Main Menu	Submenu	Menu Selections	Options	Descriptions	Page
2.Copy	1.Quality	—	Text Photo Auto*	You can choose the Copy resolution for your type of document.	34
	2.FB Txt Quality	—	1200x600dpi 600dpi*	You can change to the higher Copy resolution when you make a text copy with 100% ratio using the scanner glass.	34
	3.Brightness	—	-□□□■+ -□□□□+ -□□■□+* -□■□□+ -■□□□+	Adjust the brightness for copies.	35
	4.Contrast	—	-□□□■+ -□□□□+ -□□■□+* -□■□□+ -■□□□+	Adjust the contrast for copies.	35
3.Printer	1.Emulation	—	Auto (EPSON)* Auto (IBM) HP LaserJet BR-Script 3 Epson FX-850 IBM Proprinter	Chooses the emulation mode.	See the <i>Software User's Guide</i> on the CD-ROM.
	2.Print Options	1.Internal Font	1.HP LaserJet 2.BR-Script 3	Prints a list of the machine's internal fonts.	
		2.Configuration	—	Prints a list of the machine's printer settings.	
		3.Test Print	—	Prints a test page.	
	3.Duplex	—	Off* On (Long Edge) On (Short Edge)	Enables or disables duplex printing. You can also choose long edge or short edge duplex printing.	
4.Reset Printer	—	1.Reset 2.Exit	Restores the printer settings to the original factory default settings.		

Main Menu	Submenu	Menu Selections	Options	Descriptions	Page
4.USB Direct I/F	1.Direct Print	1.Paper Size	A4* Letter Legal Executive A5 A5 L A6 B5 B6 Folio	Sets the paper size when printing directly from the USB flash memory drive. A5 L and A6 size are not available for the optional Tray #2.	43
		2.Media Type	Thin Plain* Thick Thicker Recycled Paper	Sets the media type when printing directly from the USB flash memory drive.	43
		3.Multiple Page	1in1* 2in1 4in1 9in1 16in1 25in1 1 in 2x2 pages 1 in 3x3 pages 1 in 4x4 pages 1 in 5x5 pages	Sets the page style when printing multiple pages directly from the USB Flash memory drive.	43
		4.Orientation	Portrait* Landscape	Sets the page orientation when printing directly from the USB Flash memory drive.	43
		5.Collate	On* Off	Enables or disables the page collation when printing directly from the USB Flash memory drive.	43
		6.Print Quality	Normal* Fine	Sets the print quality option when printing directly from the USB Flash memory drive.	43
		7.PDF Option	Document* Document&Markup Document&Stamps	Sets the PDF option whether to print comments (Markup) or stamps in the PDF file along with the text.	43

Main Menu	Submenu	Menu Selections	Options	Descriptions	Page
4.USB Direct I/F (Continued)	1.Direct Print (Continued)	8.Index Print	Simple* Details	Sets the index print option, simple format or details.	43
		2.Scan to USB	1.Resolution	Color 100 dpi*	Sets the resolution to send the scanned data to USB Flash memory drive.
	Color 200 dpi Color 300 dpi Color 600 dpi Gray 100 dpi Gray 200 dpi Gray 300 dpi B&W 200 dpi B&W 200x100 dpi				
		2.File Name	—	Enter the file name of the scanned data.	

Main Menu	Submenu	Menu Selections	Options	Descriptions	Page
5.Network	1.TCP/IP	1.Boot Method	Auto* Static RARP BOOTP DHCP	Chooses the BOOT method that best suits your needs.	See the <i>Network User's Guide</i> on the CD-ROM.
		2.IP Address	[000-255]. [000-255]. [000-255]. [000-255]	Enter the IP address.	
		3.Subnet Mask	[000-255]. [000-255]. [000-255]. [000-255]	Enter the Subnet mask.	
		4.Gateway	[000-255]. [000-255]. [000-255]. [000-255]	Enter the Gateway address.	
		5.Node Name	BRNXXXXXXXXXXXX	Enter the Node name.	
		6.WINS Config	Auto* Static	Chooses the WINS configuration mode.	
		7.WINS Server	(Primary) [000-255]. [000-255]. [000-255]. [000-255] (Secondary) [000-255]. [000-255]. [000-255]. [000-255]	Specifies the IP address of the primary or secondary WINS server.	
		8.DNS Server	(Primary) [000-255]. [000-255]. [000-255]. [000-255] (Secondary) [000-255]. [000-255]. [000-255]. [000-255]	Specifies the IP address of the primary or secondary DNS server.	
		9.APIPA	On* Off	Automatically allocates the IP address from the link-local address range.	
		0.IPv6	On Off*	Enable or Disable the IPv6 protocol. If you want to use the IPv6 protocol, visit http://solutions.brother.com/ for more information.	

Main Menu	Submenu	Menu Selections	Options	Descriptions	Page	
5. Network (continued)	2. Ethernet	—	Auto* 100B-FD 100B-HD 10B-FD 10B-HD	Chooses the Ethernet link mode.	See the <i>Network User's Guide</i> on the CD-ROM.	
	3. Scan To FTP	—	Color 100 dpi* Color 200 dpi Color 300 dpi Color 600 dpi Gray 100 dpi Gray 200 dpi Gray 300 dpi B&W 200 dpi B&W 200x100 dpi	Chooses the file format to send the scanned data via FTP.		
	4. ScanTo Network	—	Color 100 dpi* Color 200 dpi Color 300 dpi Color 600 dpi Gray 100 dpi Gray 200 dpi Gray 300 dpi B&W 200 dpi B&W 200x100 dpi	You can scan a black and white or colour document directly to a CIFS server on your local network or on the internet.		
	5. Time Zone	—	UTCXXX:XX	Sets the time zone for your country.		
	0. Network Reset	1. Reset		1. Yes 2. No		Restore all network settings to factory default.
		2. Exit		—		

Main Menu	Submenu	Menu Selections	Options	Descriptions	Page
6.Machine Info.	1.Date&Time	—	—	Allows the machine to name files created when using the Scan to USB feature.	See <i>Quick Setup Guide</i> .
	2.Auto Daylight	—	On* Off	Changes for Daylight Savings Time automatically.	24
	3.Serial No.	—	—	You can check the serial number of your machine.	100
	4.Page Counter	—	Total List Copy Print	You can check the number of total pages the machine has printed during its life.	100
	5.User Settings	—	—	Lists your current settings.	26
	6.Network Config	—	—	Lists your network settings.	26
	7.Parts Life	1.Drum 2.Fuser 3.Laser 4.PF kit MP 5.PF kit 1 6.PF Kit 2	—	You can check the percentage of a machine part's life that remains available. PF Kit 2 appears only when the optional LT5300 tray is installed.	101

Entering text

When setting certain menu selections, you will need to type text characters. The dial pad keys have letters printed on them. The keys: **0**, **#** and ***** do *not* have printed letters because they are used for special characters.

Press the appropriate dial pad key the number of times shown in this reference table to access the character you want.

Press Key	one time	two times	three times	four times	five times	six times	seven times	eight times	nine times
1	@	.	/	1	@	.	/	1	@
2	a	b	c	A	B	C	2	a	b
3	d	e	f	D	E	F	3	d	e
4	g	h	i	G	H	I	4	g	h
5	j	k	l	J	K	L	5	j	k
6	m	n	o	M	N	O	6	m	n
7	p	q	r	s	P	Q	R	S	7
8	t	u	v	T	U	V	8	t	u
9	w	x	y	z	W	X	Y	Z	9

For menu selections that do not allow lower case character selection, please use this reference table.

Press Key	one time	two times	three times	four times	five times
2	A	B	C	2	A
3	D	E	F	3	D
4	G	H	I	4	G
5	J	K	L	5	J
6	M	N	O	6	M
7	P	Q	R	7	P
8	T	U	V	8	T
9	W	X	Y	9	W

Inserting spaces

To enter a space in a number, press ► once between numbers. To enter a space in a name, press ► twice between characters.

Making corrections

If you entered a letter incorrectly and want to change it, press ◀ to move the cursor to the incorrect character, and then press **Clear/Back**.

Repeating letters

To enter a character on the same key as the previous character, press ► to move the cursor right before pressing the key again.

Special characters and symbols

Press *, # or 0, then press ◀ or ▶ to move the cursor to the symbol or character you want. Press **OK** to choose it. The symbols and characters below will appear depending on your menu selection.

Press *	for	(space) ! " # \$ % & ' () * + , - . / €
Press #	for	: ; < = > ? @ [] ^ _ \ ~ ' { }
Press 0	for	Ä Ë Ö Ü À Ç È É 0

General

Printer Type	Laser	
Print Method	Electrophotography by semiconductor laser beam scanning	
Memory Capacity	64 MB	
LCD (liquid crystal display)	22 characters × 5 lines	
Power Source	220 - 240V 50/60Hz	
Power Consumption	Peak:	1080 W
	Copying:	Average 680 W ¹
	Sleep:	Average 16 W
	Standby:	Average 85 W

¹ When making a copy from one sheet

Dimensions

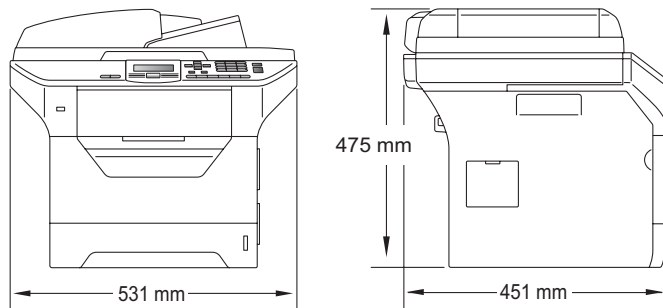

Weight	With Drum/Toner Unit:	18.4 kg
---------------	-----------------------	---------

Noise level

Sound power

Operating (Copying) ¹: LwAd = 6.54 Bell

Office equipment with LwAd > 6.30 Bell (A) is not suitable for use in room where people do primarily intellectual work. Such equipment should be placed in separate rooms because of the noise emission.

Standby: LwAd = 4.0 Bell

Sound pressure

Operating (Copying): LPAM 56 dB (A)

Standby: LPAM 30 dB (A)

¹ Measured in accordance with ISO9296.

Temperature	Operating: 10 to 32.5°C Storage: 5 to 35°C
Humidity	Operating: 20 to 80% (without condensation) Storage: 10 to 90% (without condensation)
ADF (automatic document feeder)	Up to 50 pages (Staggered) [80 g/m ²] Recommended Environment for Best Results: Temperature: 20 to 30°C Humidity: 50% - 70% Paper: Xerox Premier TCF 80 g/m ² or Xerox Business 80 g/m ²
Paper Tray	250 Sheets [80 g/m ²]
Paper Tray 2 (option)	250 Sheets [80 g/m ²]

Print media

Paper Input

Paper Tray

- Paper Type: Thin paper, Plain paper, Bond paper, Transparencies ¹ or Recycled paper
- Paper Size: Letter, A4, B5 (ISO), A5, A5 (Long Edge), B6 (ISO), A6 and Executive
- Paper Weight: 60 to 105 g/m²
- Maximum Paper Tray Capacity: Up to 250 sheets of 80 g/m² Plain paper

Multi-purpose tray (MP tray)

- Paper Type: Thin paper, Plain paper, Thick paper, Bond paper, Transparencies, Recycled paper, Envelopes or Labels ¹
- Paper Size: Width: 69.8 to 216 mm
Length: 116 to 406.4 mm
- Paper Weight: 60 to 163 g/m²
- Maximum Multi-purpose tray Capacity: Up to 50 sheets of 80 g/m² Plain paper
Up to 3 envelopes

¹ For transparencies or labels, we recommend removing printed pages from the output paper tray immediately after they exit the machine to avoid the possibility of smudging.

Paper Tray 2 (option)

- Paper Type: Thin paper, Plain paper, Bond paper or Recycled paper
- Paper Size: Letter, A4, B5 (ISO), A5, B6 (ISO), Executive
- Paper Weight: 60 to 105 g/m²
- Maximum paper tray capacity: Up to 250 sheets of 80 g/m² Plain paper

Paper Output	Output Tray	Up to 150 sheets (face down print delivery to the output paper tray)
	Back Output Tray	One sheet (face-up print delivery to the back output tray)
Duplex Printing	■ Paper Size	A4
	■ Manual Duplex	Yes
	■ Automatic Duplex	Yes

Copy

Colour/Monochrome	Monochrome
Single-sided Document Size	ADF Width: 148 to 215.9 mm ADF Length: 148 to 355.6 mm Scanner Glass Width: Max. 215.9 mm Scanner Glass Length: Max. 355.6 mm
2-Sided (Duplex) Document Size	ADF Width: 148 to 215.9 mm ADF Length: 148 to 297.0 mm
Copy Width:	Max. 210 mm
Multiple Copies	Stacks or Sorts up to 99 pages
Reduce/Enlarge	25% to 400% (in increments of 1%)
Resolution	Max. 1200 × 600 dpi (print) ¹
First Copy Out Time	Less than 10.5 seconds (from READY mode) ²

¹ 1200 x 600 dpi when copying with Text quality, 100% ratio and from scanner glass.

² The first copy out time may vary depending on scanner lamp warm up time.

Scan

Colour/Monochrome	Yes/Yes
Duplex Scanning	Yes
TWAIN Compliant	Yes (Windows® 2000 Professional/XP/ XP Professional x64 Edition/Windows Vista®) Mac OS® X 10.3.9 or greater ¹
WIA Compliant	Yes (Windows® XP/Windows Vista®)
Colour Depth	24 bit colour
Resolution	Up to 19200 × 19200 dpi (interpolated) ² Up to 600 × 2400 dpi (optical) ² (From Scanner Glass) Up to 600 × 1200 dpi (optical) ² (From ADF)
Single-Sided Document Size	ADF Width: 148.0 to 215.9 mm ADF Length: 148.0 to 355.6 mm Scanner Glass Width: Max. 215.9 mm Scanner Glass Length: Max. 355.6 mm
2-Sided (Duplex) Document Size	ADF Width: 148.0 to 215.9 mm ADF Length: 148.0 to 297.0 mm
Scanning Width	Max. 212 mm
Greyscale	8 bit levels

¹ For the latest driver updates, visit <http://solutions.brother.com/>

² Maximum 1200 × 1200 dpi scanning with the WIA driver in Windows® XP/Windows Vista® (resolution up to 19200 × 19200 dpi can be chosen by using the Brother scanner utility)

Print

Emulations	PCL6, BR-Script3 (PostScript [®] 3), IBM Pro-Printer XL, Epson FX-850
Printer Driver	Host-Based Driver for Windows [®] 2000 Professional/ XP/XP Professional x64 Edition/Windows Vista [®] / Windows Server [®] 2003 ¹ /Windows Server [®] 2003 x64 Edition ¹ / Windows Server [®] 2008 ¹
	BR-Script3 (PPD file) for Windows [®] 2000 Professional/ XP/XP Professional x64 Edition/Windows Vista [®] / Windows Server [®] 2003 ¹ /Windows Server [®] 2003 x64 Edition ¹ / Windows Server [®] 2008 ¹
	Macintosh [®] Printer Driver for Mac OS [®] X 10.3.9 or greater ² BR-Script3 (PPD file) for Mac OS [®] X 10.3.9 or greater ²
Resolution	1200 dpi, HQ1200 (2400 × 600 dpi), 600 dpi, 300 dpi
Print Speed for Simplex	Up to 30 pages/minute (A4 size) ³
Print Speed for Duplex Printing	Up to 13 sides/minute (A4 size)
First Print Out Time	Less than 8.5 seconds (from the READY state and standard tray)

¹ Print only via network

² For the latest driver updates, visit <http://solutions.brother.com/>

³ The print speed may change depending on the type of document you print.

Interfaces

Parallel	A bi-directional shielded parallel cable that is IEEE 1284 compliant and no longer than 2 m. ¹
USB	Use a USB 2.0 interface cable (type A/B) that is no longer than 2 m. ^{2 3}
LAN cable	Use an Ethernet UTP cable category 5 or greater.

- ¹ Parallel cable is not supported for Window Vista®, Windows Server® 2003, Windows Server® 2003 x64 Edition and Windows Server® 2008.
- ² Your machine has a Hi-Speed USB 2.0 interface. The machine can also be connected to a computer that has a USB 1.1 interface.
- ³ Third party USB ports are not supported for Macintosh®.

Direct Print feature

Compatibility

PDF version 1.7¹, JPEG, Exif + JPEG, PRN (created by Brother printer driver), TIFF (scanned by all Brother MFC or DCP models), PostScript®3™ (created by Brother BR-Script 3 printer driver), XPS version 1.0.

¹ PDF data including a JBIG2 image file, a JPEG2000 image file or transparency files are not supported.

Computer requirements

Minimum System Requirements and Supported PC Software Functions								
Computer Platform & Operating System Version		Processor Minimum Speed	Minimum RAM	Recommended RAM	Hard Disk Space to install		Supported PC Software Functions	Supported PC Interface ³
					For Drivers	For Applications		
Windows® Operating System ¹	Windows® 2000 Professional ⁴	Intel® Pentium® II or equivalent	64 MB	256 MB	150 MB	310 MB	Printing, Scanning	USB 10/100 Base-Tx (Ethernet) Parallel
	Windows® XP Home® ^{2 4} Windows® XP Professional ^{2 4}		128 MB					
	Windows® XP Professional x64 Edition ²	64-bit (Intel® 64 or AMD64) supported CPU	256 MB	512 MB				
	Windows Vista® ²	Intel® Pentium® 4 or equivalent 64-bit (Intel® 64 or AMD64) supported CPU	512 MB	1 GB	500 MB	500 MB		
	Windows Server® 2003 (print only via network)	Intel® Pentium® III or equivalent	256 MB	512 MB	50MB	N/A	Printing	10/100 Base-Tx (Ethernet)
	Windows Server® 2003 x64 Edition (print only via network)	64-bit (Intel® 64 or AMD64) supported CPU						
	Windows Server® 2008 (print only via network)	Intel® Pentium® 4 or equivalent 64-bit (Intel® 64 or AMD64) supported CPU	512 MB	2 GB				

Macintosh® Operating System	MacOS® X 10.3.9 - 10.4.3	PowerPC G4/G5, PowerPC G3 350MHz	128 MB	256 MB	80 MB	400 MB	Printing, Scanning	USB 10/100 Base-Tx (Ethernet)
	MacOS® X 10.4.4 or greater	PowerPC G4/G5, Intel® Core™ Processor	512 MB	1 GB				

¹ Internet Explorer® 5.5 or greater.

² For WIA, 1200x1200 resolution. Brother Scanner Utility enables to enhance up to 19200 x 19200 dpi.

³ Third party USB/Pararell ports are not supported.

⁴ PaperPort™ 11SE supports Microsoft® SP4 or higher for Windows® 2000 and SP2 or higher for XP.

For the latest driver updates, visit <http://solutions.brother.com>

All trademarks, brand and product names are property of their respective companies.

Consumable items

Toner Cartridge Life

Standard Toner Cartridge:

TN-3230:

Approx. 3,000 pages (A4) ¹

High-Yield Toner Cartridge:

TN-3280:

Approx. 8,000 pages (A4) ¹

Drum Unit

DR-3200:

Approx. 25,000 pages (A4) ²

¹ Approx. cartridge yield is declared in accordance with ISO/IEC 19752.

² Drum yield is approximate, and may vary by type of use.

Ethernet wired network

Network board model name	NC-6800h type2
LAN	You can connect your machine to a network for Network Printing, Network Scanning. ¹
Support for	Windows [®] 2000 Professional, Windows [®] XP, Windows [®] XP Professional x64 Edition, Windows Vista [®] , Windows Server [®] 2003 ¹ , Windows Server [®] 2003 x64 Edition ¹ , Windows Server [®] 2008 ¹ Mac OS [®] X 10.3.9 or greater ²
Protocols	IPv4: ARP, RARP, BOOTP, DHCP, APIPA (Auto IP), WINS/NetBIOS name resolution, DNS Resolver, mDNS, LLMNR responder, LPR/LPD, Custom Raw Port/Port9100, IPP/IPPS, FTP Client and Server, TELNET Server, HTTP/HTTPS Server, SSL/TLS, TFTP Client and Server, SMTP Client, APOP, POP before SMTP, SMTP AUTH, SNMPv1/v2c/v3, ICMP, LLTD responder, Web Services Print, CIFS Client, SNTP IPv6: (Turned off as default) NDP, RA, DNS resolver, mDNS, LPR/LPD, Custom Raw Port/Port9100, IPP/IPPS, LLMNR responder, FTP Client and Server, TELNET Server, HTTP/HTTPS server, SSL/TLS, TFTP Client and Server, SMTP Client, APOP, POP before SMTP, SMTP AUTH, SNMPv1/v2c/v3, ICMPv6, LLTD responder, Web Services Print, CIFS Client, SNTP
Network type	Ethernet 10/100 BASE-TX Auto Negotiation (Wired LAN)

Management utilities³

BRAdmin Light for Windows[®] 2000 Professional, Windows[®] XP, Windows[®] XP Professional x64 Edition, Windows Vista[®], Windows Server[®] 2003, Windows Server[®] 2003 x64 Edition, Windows Server[®] 2008 and Mac OS[®] X 10.3.9 or greater

BRAdmin Professional for Windows[®] 2000 Professional, Windows[®] XP, Windows[®] XP Professional x64 Edition, Windows Vista[®], Windows Server[®] 2003, Windows Server[®] 2003 x64 Edition and Windows Server[®] 2008

Web BRAdmin for Windows[®] 2000 Professional, Windows[®] XP, Windows[®] XP Professional x64 Edition, Windows Vista[®], Windows Server[®] 2003, Windows Server[®] 2003 x64 Edition and Windows Server[®] 2008

Client computers with a web browser supporting Java.

¹ Print only via network

² Mac OS[®] X 10.3.9 or greater (mDNS)

³ BRAdmin Professional and Web BRAdmin are available as a download from <http://solutions.brother.com/>

F

Glossary

This is a comprehensive list of features and terms that appear in Brother manuals. Availability of these features depends on the model you purchased.

ADF (automatic document feeder)

The document can be placed in the ADF and scanned one page at a time automatically.

Beeper Volume

Volume setting for the beep when you press a key or make an error.

Cancel Job

Cancels a programmed print job and clears the machine's memory.

Contrast

Setting to compensate for dark or light documents, by making copies of dark documents lighter and light documents darker.

Fine resolution

Resolution is 203 × 196 dpi. It is used for small print and graphs.

Greyscale

The shades of grey available for copying photographs.

LCD (liquid crystal display)

The display screen on the machine that shows interactive messages during On-Screen Programming and shows the date and time when the machine is idle.

Menu mode

Programming mode for changing your machine's settings.

OCR (optical character recognition)

The bundled ScanSoft™ PaperPort™ 11SE with OCR or Presto! PageManager software application converts an image of text to text you can edit.

Resolution

The number of vertical and horizontal lines per inch.

Scanning

The process of sending an electronic image of a paper document into your computer.

User Settings List

A printed report that shows the current settings of the machine.

A

- ADF (automatic document feeder)
 - using20
- Apple® Macintosh®
 - See Software User's Guide on the CD-ROM.

C

- Cancelling
 - print jobs7
- Cleaning
 - corona wire90
 - drum unit91
 - laser scanner window88
 - scanner glass87
- Consumable items94
- Control panel overview6
- ControlCenter2 (for Macintosh®)
 - See Software User's Guide on the CD-ROM.
- ControlCenter3 (for Windows®)
 - See Software User's Guide on the CD-ROM.
- Copy
 - contrast 32, 35
 - duplex 37, 38
 - Enlarge/Reduce key33
 - enter copy mode32
 - keys 6, 33
 - multiple32
 - N in 1 (page layout)36
 - out of memory39
 - quality34
 - single32
 - sort (ADF only)34
 - temporary settings33
 - tray selection39
 - using ADF34
 - using scanner glass36

D

- Direct print42
 - Direct key43
 - specification126

- Document
 - how to load20, 21
 - jam79
- Drum unit
 - checking (remaining life)101
 - cleaning90, 91
 - replacing98
- Duplex (2-sided)
 - copying37, 38
 - printing
 - from USB flash memory drive44
 - troubleshooting80
- Duplex key (2-sided)37, 38

E

- Enlarge/Reduce key33
- Envelopes11, 14, 18
- Error messages on LCD75
 - No Paper76
 - Out of Memory76
 - Print Unable XX76
 - Scan Unable XX77

F

- Folio16

G

- Greyscale123

H

- HELP
 - LCD messages104
 - Menu Table104, 106
 - using menu keys104

J

- Jams
 - document79
 - paper80
- Job Cancel key7

L

Labels	11, 14, 16, 19
LCD (liquid crystal display)	6, 104
contrast	25

M

Machine information	
checking remaining life of drum unit and periodic maintenance parts	101
page counts	100
status LED	8
Macintosh®	
See Software User's Guide on the CD-ROM.	
Maintenance, routine	86
checking the remaining life of drum unit and periodic maintenance parts	101
replacing	
drum unit	98
toner cartridge	95
Memory	
adding SO-DIMM (option)	61
installing	62
storage	104
Menu Table	104, 106
using menu keys	104
Mode, entering	
copy	32

N

N in 1 (page layout)	36
Network	
printing	
See Network User's Guide on the CD-ROM.	
scanning	
See Software User's Guide on the CD-ROM.	

O

Out of Memory message	39, 45, 76
-----------------------------	------------

P

Packing and shipping the machine	102
Page layout (N in 1)	36
Paper	14, 120
how to load	10
jam	80
recommended	14, 16
size	15, 22
size of document	122, 123
tray capacity	16
type	15, 22
PaperPort™ 11SE with OCR	
See Software User's Guide on the CD-ROM and Help in the PaperPort™ 11SE application to access How-to-Guides.	
Power failure	104
Print	
difficulties	63
drivers	124
Job Cancel key	7
keys	7
paper jams	80
quality	65, 68
resolution	124
Secure key	7
specifications	124
Printing	
See Software User's Guide on the CD-ROM.	
Programming your machine	104

Q

Quality	
copying	34
printing	65, 68

R

Reducing	
copies	33
Replacing	
drum unit	98
toner cartridge	95

Resolution	
copy	122
print	124
scan	123
Restricted users	29

S

Safety instructions	57
Scan	7
Scanner glass	
using	21
Scanning	
See Software User's Guide on the CD-ROM.	
Secure key	7
Security	
Secure function lock	
administrator password	27
Public user	28
restricted users	29
Secure key	7
Serial number	
how to find	See inside front cover
Shipping the machine	102
Sleep time	25
Sort	34
Status LED	8

T

Temporary copy settings	33
Text, entering	116
Toner cartridge, replacing	95
Toner save	24
Transparency	10, 11, 14
Tray selection	39
Tray use, setting	
copy	23
print	23

Troubleshooting	63
document jam	79
error messages on LCD	75
if you are having difficulty	
copy quality	63
network	65
paper handling	64
print quality	65, 68
printing	63
scanning	64
software	64
maintenance messages on LCD	75
paper jam	80

V

Volume, setting	
beeper	24

W

Windows®	
See Software User's Guide on the CD-ROM.	

brother[®]

This machine is approved for use in the country of purchase only. Local Brother companies or their dealers will only support machines purchased in their own countries.